



VAN CARE



VAN RACKING
MERCEDES-BENZ

ABOUT US

Van Care has been a manufacturer in the field of commercial vehicle Van Racking Kits for many years. Our head office is located in Beek, The Netherlands, and our team consists of four employees. The production site is based in Poland, and has 100 employees.

Van Care offers a suitable solution for every commercial vehicle. We work with lightweight modular equipment and provide tailor-made solutions. The modular construction allows you to put together your ideal interior with the exact shelves, drawers and spaces you need.



Thanks to an extensive network of specialized dealers, we can deliver fully customized Van Racking. Kits tailored specifically to your needs. Feel free to contact us for more information and an introductory conversation.

VAN CARE PRODUCTS

Van Care products are innovative, lightweight and durable. All products are made of ultra-high strength materials, resulting in minimal weight and maximum loading capacity.



THE BEST
QUALITY



FREE
CONSULTANCY



COST
REDUCTION

SAFETY

All Van Care's Van Racking Kits are tested extensively. Crash tests are continuously being carried out at specialized research centers.

Simulation, load capacity and vibration tests are continuously researched and performed.

Time and time again our products have proven to be extremely safe. Take these results from one of our frontal impact tests for example.



The speed of the crash test was increased from 32km/h to 50km/h. According to the report, the material had been deformed, but without creating dangerous situations for the passengers due to the loosening of parts.

SAFETY & QUALITY

ARE OUR MAIN GOALS

PROVEN QUALITY OF OUR PRODUCTS

Van Care guarantees optimal safety, today and in the future. Everything is made for functional use and safety during work and transport. The production is fully certified and complies to ISO 9001:2015 and TÜV requirements.

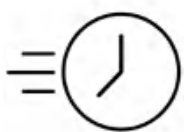

TIME
SAVING



PERSONALIZED
PROJECT



GREAT
TESTS RESULTS





CONTENT LIST:

CITAN

MODULES:

WHEEL BASE: 2697 MM 6-7

WHEEL BASE: 3081 MM 8-9

XLD LINE:

WHEEL BASE: 2697 MM 10

WHEEL BASE: 3081 MM 11

VITO

MODULES:

WHEEL BASE: 3200 MM 12-13

WHEEL BASE: 3200 MM L 14-15

WHEEL BASE: 3430 MM XL 16-17

XLD LINE:

WHEEL BASE: 3200 MM 18

WHEEL BASE: 3200 MM L 19

WHEEL BASE: 3430 MM XL 19

SPRINTER

MODULES:

WHEEL BASE: 3259 MM 20-21

WHEEL BASE: 3665 MM 22-23

WHEEL BASE: 3924 MM 22-23

WHEEL BASE: 4325 MM 24-25

WHEEL BASE: 4325 MM XL 26-27



Length



Height



Depth



Weight



LEFT SIDE

Bronze Line

57-1-100-00



Standard (wheel base:2697mm)

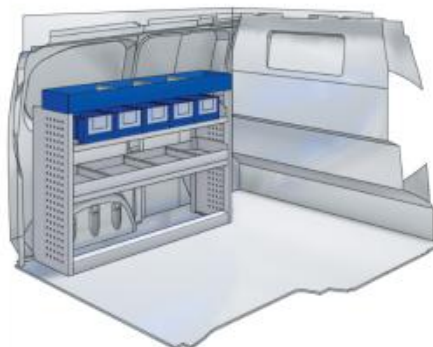

L 1267mm **H** 980mm **D** 360mm **W** 40kg

Silver Line

57-1-102-00



Standard (wheel base:2697mm)



L 1267mm **H** 980mm **D** 360mm **W** 37kg

Gold Line

57-1-104-00



Standard (wheel base:2697mm)



L 1267mm **H** 980mm **D** 360mm **W** 60kg



VAN CARE



CITAN

57-1-101-00

Bronze Line

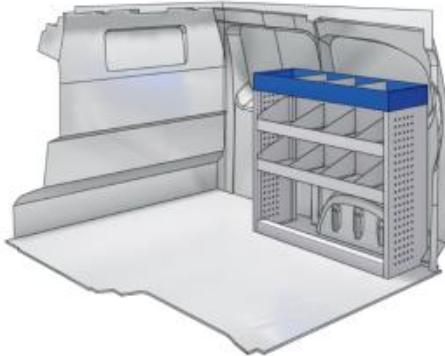

Standard (wheel base: 2697mm)

L 1014mm **H** 980mm **D** 360mm **8** 21kg

RIGHT SIDE

57-1-103-00

Silver Line



Standard (wheel base: 2697mm)

L 1014mm **H** 980mm **D** 360mm **8** 35kg

57-1-150-00

Gold Line



Standard (wheel base: 2697mm)

L 1014mm **H** 1085mm **D** 360mm **8** 56kg



LEFT SIDE

Bronze Line

57-1-106-00

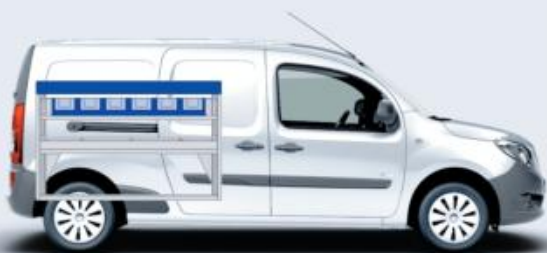

XL (wheel base: 3081mm)

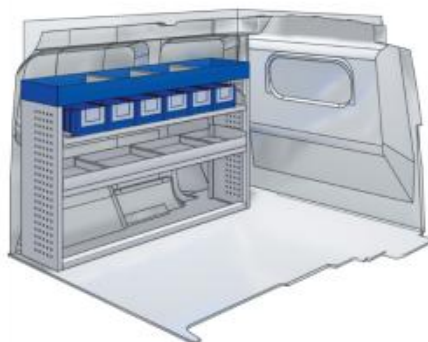

 1521mm
  980mm
  360mm
  45kg

Silver Line

57-1-107-00



XL (wheel base: 3081mm)



 1521mm
  980mm
  360mm
  45kg

Gold Line

57-1-108-00



XL (wheel base: 3081mm)

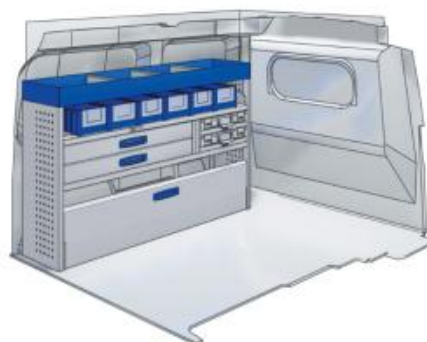

 1521mm
  980mm
  360mm
  68kg



VAN CARE



CITAN

57-1-101-00

Bronze Line

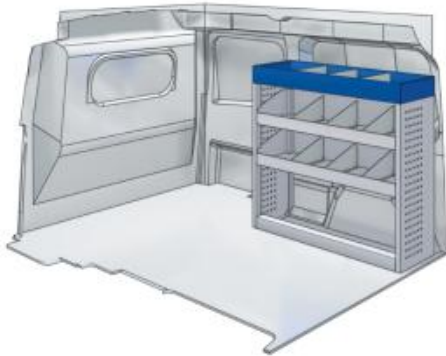

RIGHT SIDE

L 1014mm **D** 980mm **D** 360mm **8** 21kg

XL (wheel base: 3081mm)

57-1-103-00

Silver Line



L 1014mm **D** 980mm **D** 360mm **8** 35kg

XL (wheel base: 3081mm)

57-1-151-00

Gold Line



L 1014mm **D** 1085mm **D** 360mm **8** 60kg

XL (wheel base: 3081mm)

CITAN



VAN CARE

XLD LINE

Bronze Line

57-1-155-00



(wheel base: 2697mm)

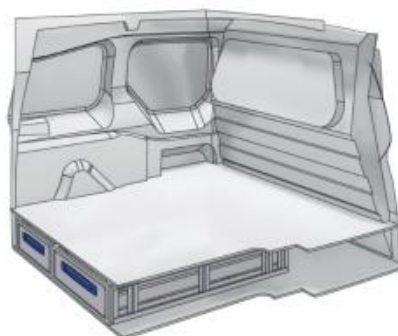

L 1026mm H 176mm D 1075mm W 41kg

Silver Line

57-1-109-00



(wheel base: 2697mm)



L 1492mm H 176mm D 1270mm W 62kg

Gold Line

57-1-110-00



(wheel base: 2697mm)



L 1492mm H 310mm D 1270mm W 111kg



VAN CARE



CITAN

57-1-156-00

Bronze Line



XL (wheel base: 3081mm)

1266mm 176mm 1075mm 44kg

57-1-148-00

Silver Line

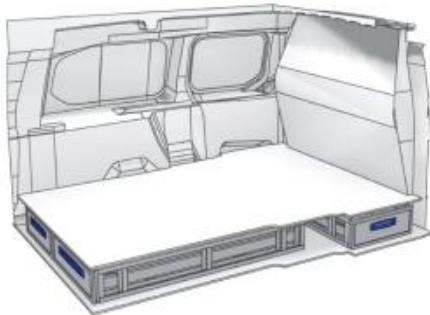

XL (wheel base: 3081mm)

1732mm 176mm 1266mm 65kg

57-1-113-00

Gold Line



XL (wheel base: 3081mm)

1732mm 310mm 1266mm 120kg



LEFT SIDE

Bronze Line

57-1-115-00



Compact (wheel base:3200mm)



1774mm
 1260mm
 360mm
 50kg

Silver Line

57-1-117-00



Compact (wheel base:3200mm)



1774mm
 1225mm
 360mm
 63kg

Gold Line

57-1-119-00



Compact (wheel base:3200mm)



1774mm
 1260mm
 360mm
 74kg



VAN CARE



VITO

57-1-116-00

Bronze Line



Compact (wheel base:3200mm)

L 1014mm **H** 1085mm **D** 360mm **KG** 40kg

RIGHT SIDE

57-1-118-00

Silver Line



Compact (wheel base:3200mm)

L 1014mm **H** 1085mm **D** 360mm **KG** 55kg

57-1-105-00

Gold Line



Compact (wheel base:3200mm)

L 1267mm **H** 1085mm **D** 360mm **KG** 63kg



LEFT SIDE

Bronze Line

57-1-120-00



Large (wheel base: 3200mm)

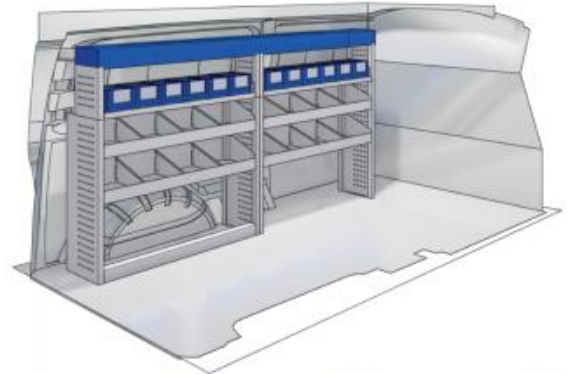

L 2028mm **H** 1260mm **D** 360mm **8** 53kg

Silver Line

57-1-122-00

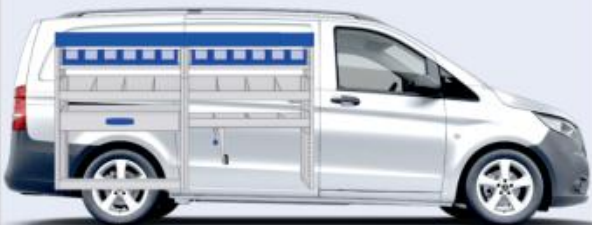

Large (wheel base: 3200mm)

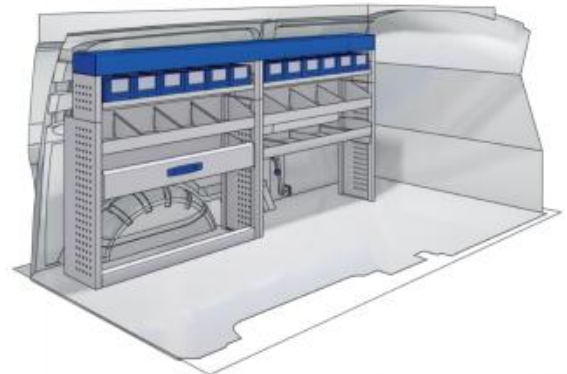

L 2028mm **H** 1225mm **D** 360mm **8** 65kg

Gold Line

57-1-124-00



Large (wheel base: 3200mm)



L 2028mm **H** 1260mm **D** 360mm **8** 78kg



VAN CARE



VITO

57-1-121-00

Bronze Line



1267mm 1085mm 360mm 48kg



Large (wheel base: 3200mm)

RIGHT SIDE

57-1-123-00

Silver Line

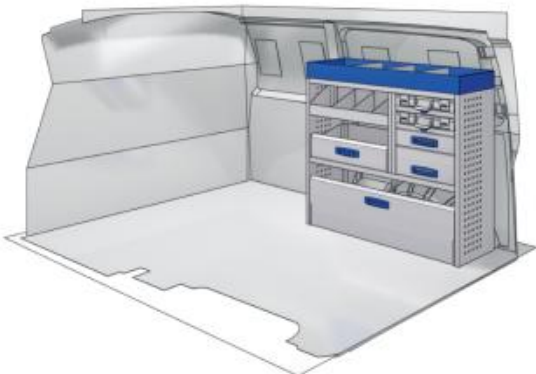

1267mm 1085mm 360mm 66kg



Large (wheel base: 3200mm)

57-1-105-00

Gold Line

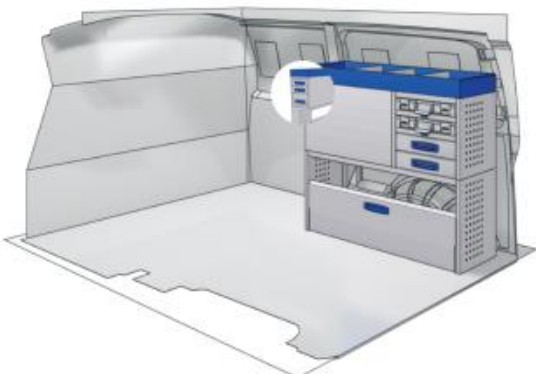

1267mm 1085mm 360mm 63kg



Large (wheel base: 3200mm)



LEFT SIDE

Bronze Line

57-1-120-00



XL (wheel base: 3430mm)

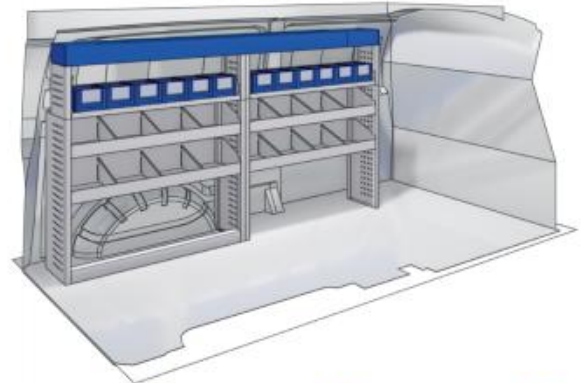

L 2028mm
 H 1260mm
 D 360mm
 W 53kg

Silver Line

57-1-122-00

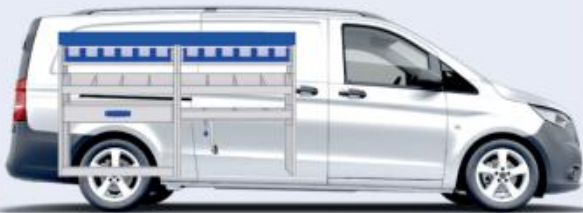

XL (wheel base: 3430mm)

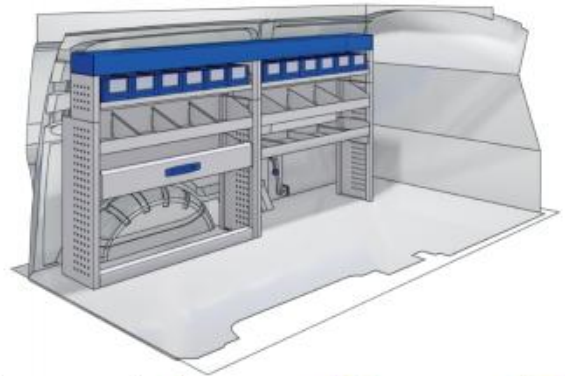

L 2028mm
 H 1225mm
 D 360mm
 W 65kg

Gold Line

57-1-124-00



XL (wheel base: 3430mm)



L 2028mm
 H 1260mm
 D 360mm
 W 78kg



VAN CARE



VITO

57-1-125-00

Bronze Line

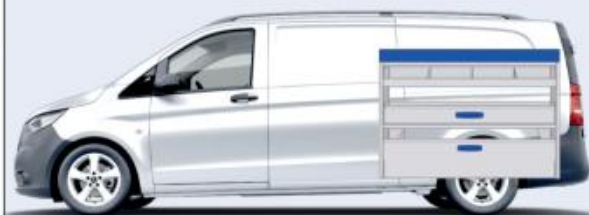
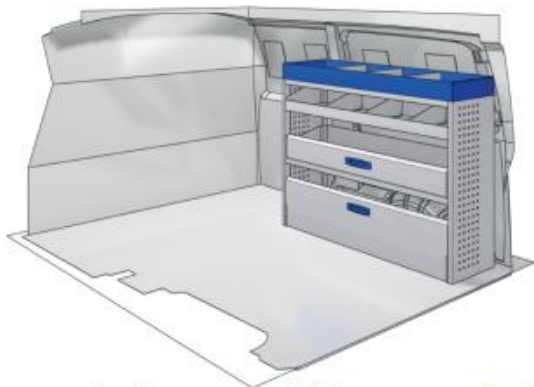

L 1521mm **H** 1085mm **D** 360mm **8** 56kg

XL (wheel base: 3430mm)

RIGHT SIDE

57-1-126-00

Silver Line



L 1521mm **H** 1085mm **D** 360mm **8** 73kg

XL (wheel base: 3430mm)

57-1-105-00

Gold Line

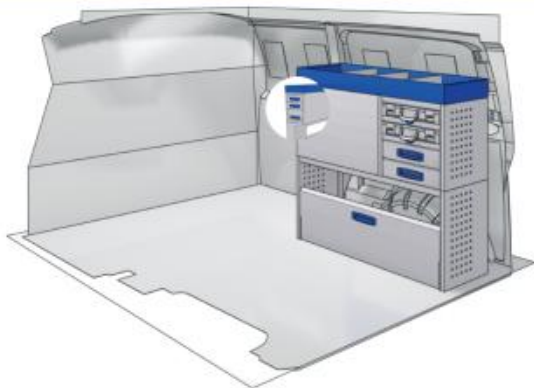

L 1267mm **H** 1085mm **D** 360mm **8** 63kg

XL (wheel base: 3430mm)

VITO



VAN CARE

Bronze Line

57-1-154-00



Compact (wheel base: 3200mm)

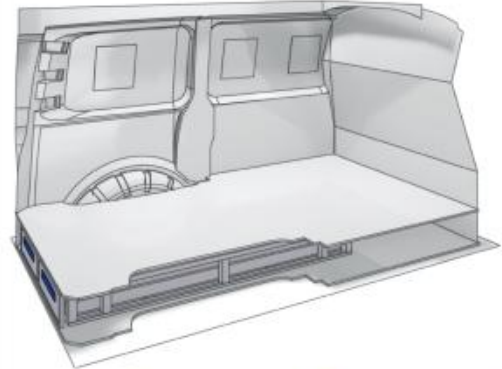

L 1526mm **H** 176mm **D** 1218mm **W** 52kg

Silver Line

57-1-127-00



Compact (wheel base: 3200mm)

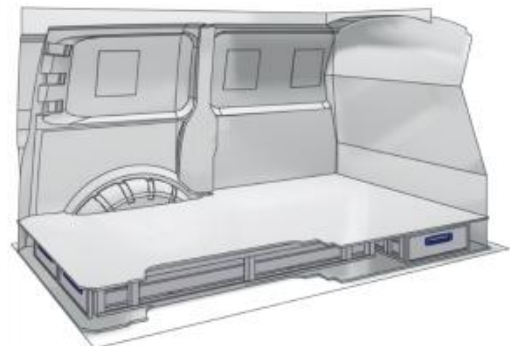

L 2106mm **H** 176mm **D** 1526mm **W** 76kg

Gold Line

57-1-128-00



Compact (wheel base: 3200mm)

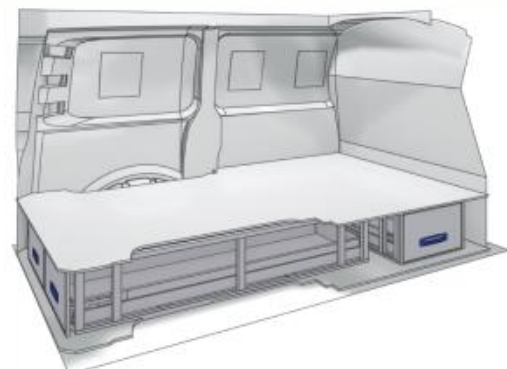

L 2106mm **H** 310mm **D** 1526mm **W** 98kg



VAN CARE



VITO

57-1-154-00

Bronze Line

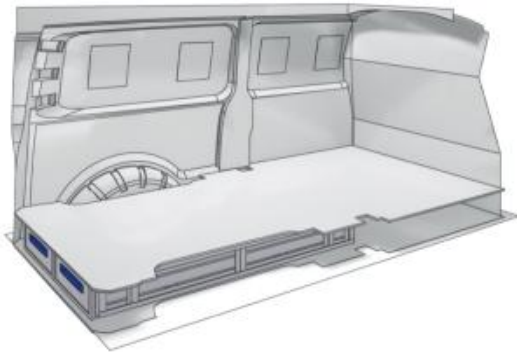

L&XL (wheel base: 3200 & 3430mm)

L 1526mm **D** 176mm **D** 1218mm **8** 52kg

57-1-130-00

Silver Line

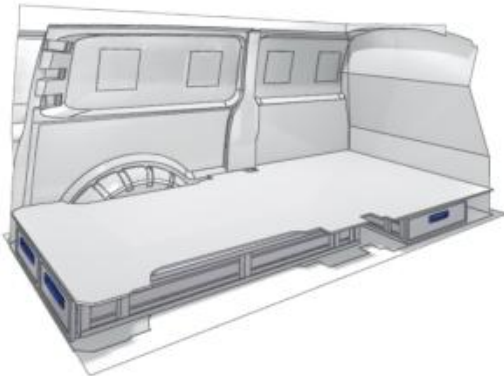

L&XL (wheel base: 3200 & 3430mm)

L 2135mm **D** 176mm **D** 1526mm **8** 76kg

57-1-131-00

Gold Line

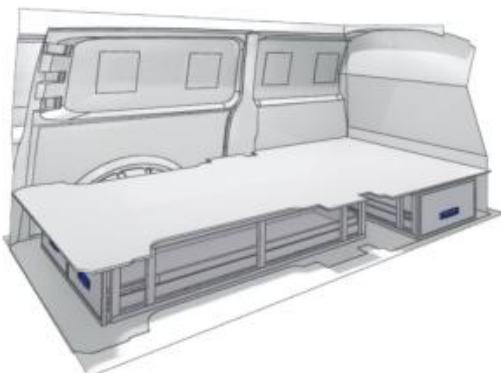

L&XL (wheel base: 3200 & 3430mm)

L 2135mm **D** 310mm **D** 1526mm **8** 99kg

SPRINTER



VAN CARE

LEFT SIDE

Bronze Line

57-1-133-00



L1 (wheel base:3259mm)

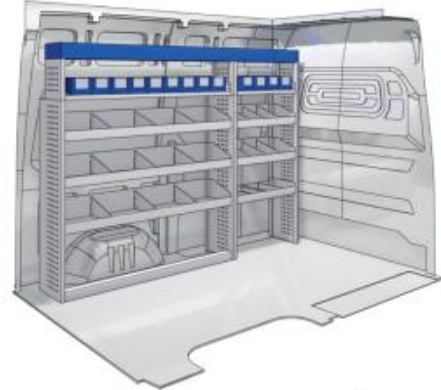

L 2281mm D 1750mm D 360mm 83 73kg

Silver Line

57-1-135-00



L1 (wheel base:3259mm)

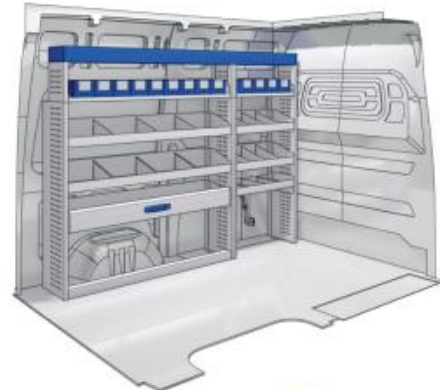

L 2281mm D 1750mm D 360mm 83 83kg

Gold Line

57-1-136-00



L1 (wheel base:3259mm)

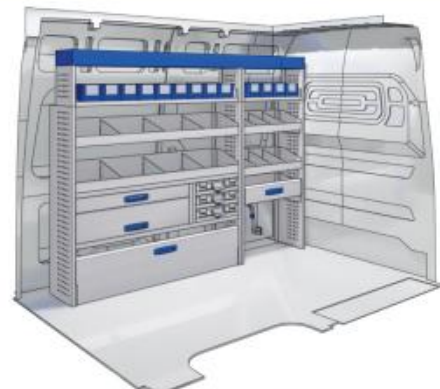

L 2281mm D 1750mm D 360mm 83 120kg



VAN CARE



SPRINTER

57-1-134-00

Bronze Line



L 1267mm **D** 1750mm **D** 360mm **B** 60kg



L1 (wheel base:3259mm)

RIGHT SIDE

57-1-123-00

Silver Line



L 1267mm **D** 1085mm **D** 360mm **B** 60kg



L1 (wheel base:3259mm)

57-1-105-00

Gold Line



L 1267mm **D** 1085mm **D** 360mm **B** 63kg



L1 (wheel base:3259mm)

SPRINTER



VAN CARE

LEFT SIDE

Bronze Line

57-1-137-00



L2 (wheel base:3665mm, 3924mm FWD)

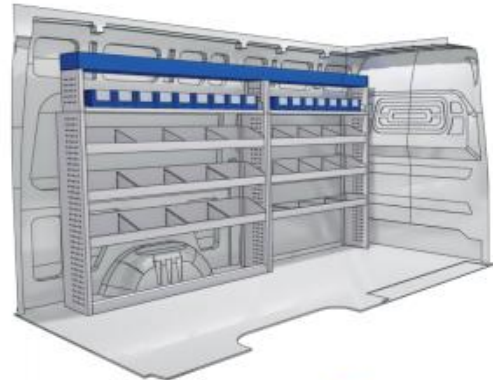

L 2788mm H 1750mm D 360mm W 80kg

Silver Line

57-1-139-00



L2 (wheel base:3665mm, 3924mm FWD)



L 2788mm H 1750mm D 360mm W 90kg

Gold Line

57-1-140-00



L2 (wheel base:3665mm, 3924mm FWD)



L 2788mm H 1750mm D 360mm W 130kg



VAN CARE



SPRINTER

57-1-138-00

Bronze Line



L 1521mm **D** 1750mm **D** 360mm **8** 66kg



L2 (wheel base:3665mm, 3924mm FWD)

RIGHT SIDE

57-1-123-00

Silver Line



L 1521mm **D** 1085mm **D** 360mm **8** 75kg



L2 (wheel base:3665mm, 3924mm FWD)

57-1-105-00

Gold Line

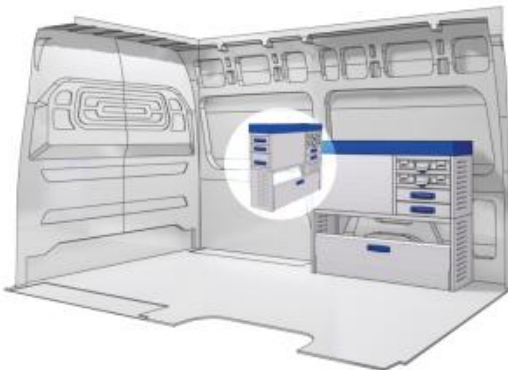

L 1267mm **D** 1085mm **D** 360mm **8** 63kg



L2 (wheel base:3665mm, 3924mm FWD)

SPRINTER



VAN CARE

LEFT SIDE

Bronze Line

57-1-142-00



L3 (wheel base:4325mm)



3802mm 1750mm 360mm 110kg

Silver Line

57-1-145-00

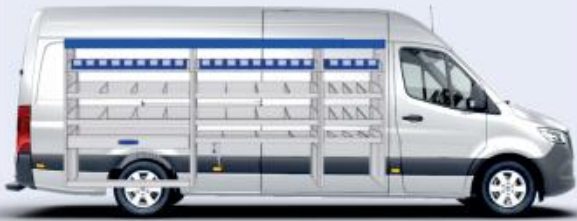

L3 (wheel base:4325mm)



3802mm 1750mm 360mm 120kg

Gold Line

57-1-146-00



L3 (wheel base:4325mm)



3802mm 1750mm 360mm 160kg



VAN CARE



SPRINTER

57-1-143-00

Bronze Line

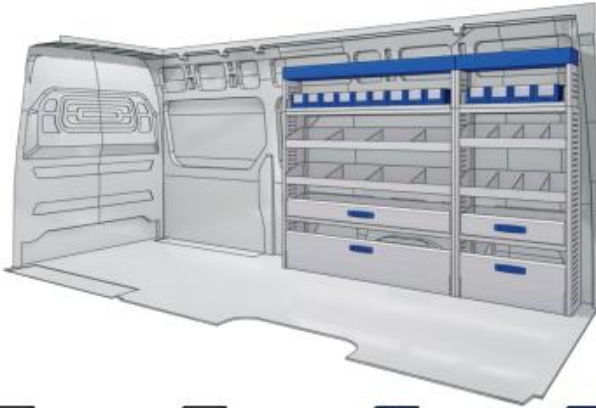

2281mm 1750mm 360mm 108kg



L3 (wheel base:4325mm)

RIGHT SIDE

57-1-152-00

Silver Line

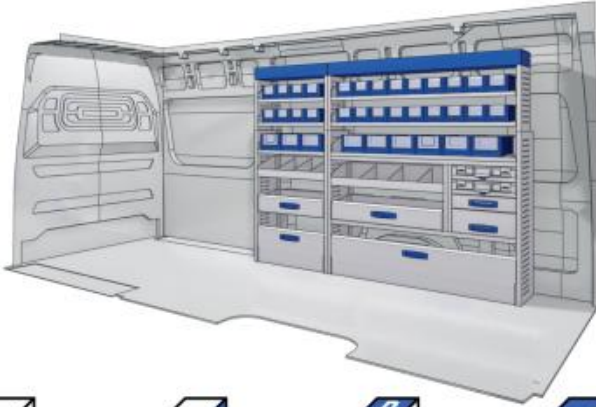

2281mm 1750mm 360mm 128kg



L3 (wheel base:4325mm)

57-1-153-00

Gold Line

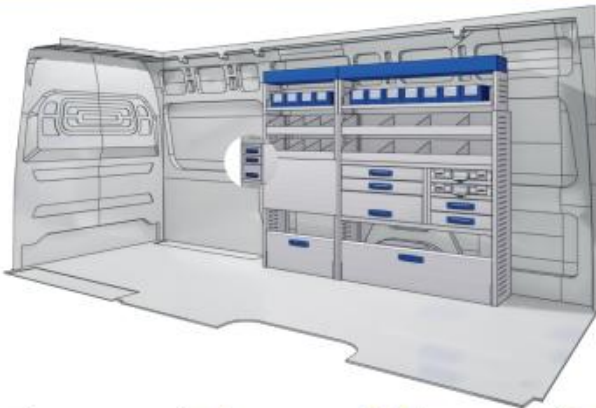

2025mm 1750mm 360mm 134kg



L3 (wheel base:4325mm)

SPRINTER



VAN CARE

LEFT SIDE

Bronze Line

57-1-142-00



L4 XL(wheel base: 4325mm)

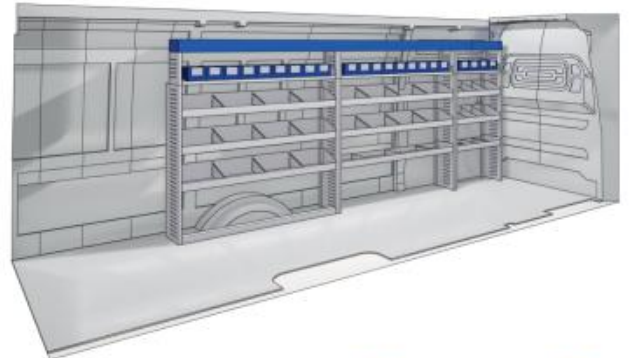

3802mm 1750mm 360mm 110kg

Silver Line

57-1-145-00



L4 XL(wheel base: 4325mm)

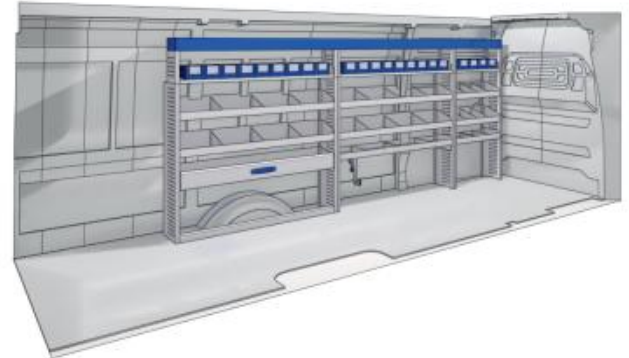

3802mm 1750mm 360mm 120kg

Gold Line

57-1-146-00



L4 XL(wheel base: 4325mm)

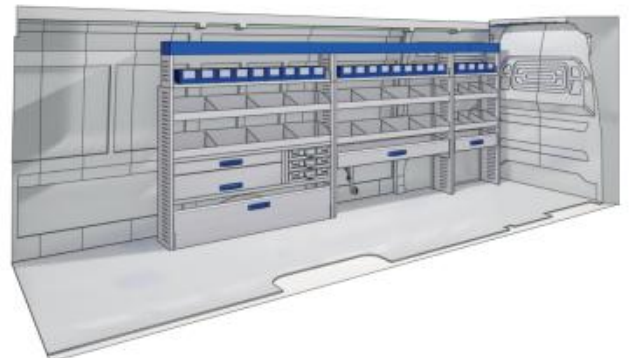

3802mm 1750mm 360mm 160kg



VAN CARE



SPRINTER

57-1-147-00

Bronze Line



L 2535mm D 1750mm D 360mm W 120kg

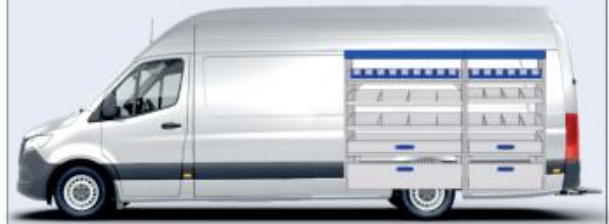

L4 XL(wheel base: 4325mm)

RIGHT SIDE

57-1-152-00

Silver Line

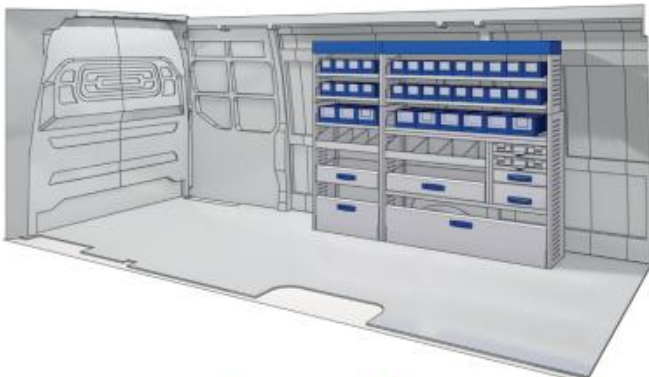

L 2281mm D 1750mm D 360mm W 128kg



L4 XL(wheel base: 4325mm)

57-1-153-00

Gold Line

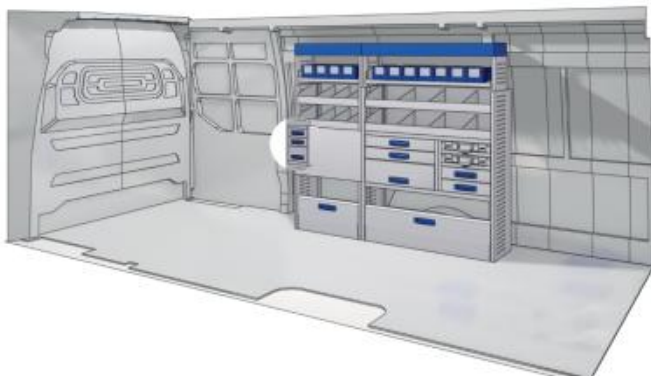

L 2025mm D 1750mm D 360mm W 134kg



L4 XL(wheel base: 4325mm)



Polychemstraat 14
6191NL Beek (Limburg) Netherlands
Phone number: +31 (0)46 4374147

