



ALLESTIMENTI VEICOLI COMMERCIALI
AMÉNAGEMENTS DE VÉHICULES UTILITAIRES



LIGHT SHELF

RIPIANI RIBALTABILI PER FURGONI
ÉTAGÈRES RABATTABLES POUR FOURGONS





Store Van è l'unico produttore al mondo di allestimenti per veicoli commerciali ad utilizzare questa tecnologia.

StoreVan est le seul fabricant d'aménagements de véhicules utilitaires au monde à utiliser cette technologie.

TECNOLOGIE

ACCIAIO GALVANNEALED

La lamiera galvannealed è una variante della lamiera zincata a caldo. Il prodotto subisce un processo di zincatura a caldo e un successivo riscaldamento ad una temperatura di ca. 550°C attraverso il quale lo zinco si salda alla superficie della lamiera formando una lega con l'acciaio.

Il risultato che si ottiene è uno strato zincato uniforme e dalla struttura cristallina fine abbinati ad una **qualità della superficie e una resistenza alla corrosione nettamente superiori**. Questo processo è ideale per le applicazioni automotive. Store Van ha introdotto e implementato tale tecnologia anche nel settore dell'allestimento veicoli industriali.

VERNICIATURA PER IMMERSIONE - CATODICA - CON RESINA ACRILICA

La verniciatura per cataforesi è un trattamento superficiale di verniciatura in grado di conferire agli elementi dell'allestimento una **notevole resistenza alla corrosione**; è caratterizzata dal **deposito uniforme** di una resina acrilica sulla superficie dell'elemento, assicurando per lungo tempo un'elevata protezione nei confronti degli agenti chimici e di altri tipi di attacchi. La resina acrilica consente una diretta esposizione agli agenti atmosferici mantenendo inalterate le caratteristiche tecniche. Con questo processo si assicura una maggiore protezione dalla ruggine.

- Resistenza alla corrosione superiore a 500 ore (umidità ASTM D1735)
- Eccellente durezza con valutazione minima 2H



STORE VAN ORANGE PLANET

Sostenibilità ambientale e sviluppo eco-compatibile sono temi di rilevante attualità ed interesse, sorti dalla crescente consapevolezza che si debba prestare attenzione all'equilibrio ambientale.

STORE VAN ORANGE PLANET

La durabilità ambientale e lo sviluppo eco-compatibile sono temi di rilevante attualità ed interesse, sorti dalla crescente consapevolezza che si debba prestare attenzione all'equilibrio ambientale.

TECNOLOGIES

ACIER GALVANNEALED

La tôle galvannealed est une variante de la tôle galvanisée à chaud. Le produit est soumis à un procédé de galvanisation à chaud, puis de chauffage à une température d'env. 550 °C par lequel le zinc se soude à la surface de la tôle en formant un alliage avec l'acier.

Le résultat obtenu est une couche de zinc uniforme et une structure cristalline fine combinées à **une qualité de la surface et une résistance à la corrosion nettement plus élevées**. Ce procédé est idéal pour les applications au sein du secteur automobile. StoreVan a introduit et optimisé cette technologie également dans le domaine des aménagements de véhicules utilitaires.

PEINTURE PAR IMMERSION - CATHODIQUE - AVEC RESINE ACRYLIQUE

La peinture cathodique est un traitement de surface qui permet de conférer aux éléments de l'aménagement **une résistance remarquable à la corrosion** ; elle est caractérisée par le **dépôt uniforme** d'une résine acrylique sur la surface de l'élément, en garantissant une haute et durable protection contre les agents chimiques et d'autres types d'agressions. La résine acrylique permet une exposition directe aux agents atmosphériques, tout en conservant inchangées les caractéristiques techniques. Ce procédé garantit aussi une meilleure protection contre la rouille.

- Résistance à la corrosion supérieure à 500 heures (humidité ASTM D1735)
- Excellente dureté avec une évaluation minimale 2H



FISSAGGIO FLESSIBILE FIXATION FLEXIBLE

FLESSIBILITÀ E DUREVOLEZZA DEGLI ALLESTIMENTI PER FURGONI STORE VAN

Store Van utilizza uno speciale sistema a binario per il fissaggio delle scaffalature per furgoni allo chassis del veicolo commerciale, conferendo una grande flessibilità al posizionamento dei moduli e massimizzando l'utilizzo degli spazi interni al furgone attrezzato.

Il sistema prevede l'utilizzo di staffe che scorrono all'interno del binario in tutta la sua lunghezza anziché esser rivettate direttamente ai rinforzi dello chassis, che obbligano, nella progettazione dell'allestimento furgone, a una sostanziale rigidità nella gestione degli spazi. Il binario usato da Store Van viene fissato ai montanti verticali dell'officina mobile, con la doppia funzione di collegare in maniera uniforme gli scaffali per furgoni al telaio del veicolo e di distribuire omogeneamente tutte le forze dinamiche a cui l'allestimento viene sottoposto durante la guida.

Le staffe di fissaggio che collegano il binario al modulo presentano uno speciale snodo che ammortizza le vibrazioni derivanti dalla guida del veicolo, adattandosi ai movimenti torsionali dello chassis, specialmente in percorrenza di curve.

Grazie a questo sistema, i nostri allestimenti per furgoni possono essere progettati con la massima libertà, garantendo comunque alti standard di sicurezza, stabilità e durevolezza nel tempo.

Tutti i nostri sistemi di fissaggio si possono avvalere di sistemi di aggancio/sgancio rapido dei moduli tramite maniglie a ripresa che permettono di smontare l'allestimento senza l'ausilio di utensili. In questo modo la scaffalatura della tua officina mobile può essere dichiarata come materiale trasportato o come ausilio alla sicurezza del carico non permanentemente fissato al veicolo, come descritto nella DIRETTIVA 2014/47 UE, CAPO 1, Articolo 3, paragrafo 5.

FLEXIBILITÉ ET DURÉE DES AMÉNAGEMENTS POUR FOURGONS STORE VAN

Store Van utilise un système à rail spécial pour la fixation des rayonnages pour fourgons au châssis du véhicule utilitaire : cela garantit une grande flexibilité pour le positionnement des modules et optimise l'utilisation des espaces à l'intérieur du fourgon aménagé.

Le système prévoit l'utilisation d'étriers qui coulissent à l'intérieur du rail sur toute sa longueur au lieu d'être rivetés directement aux renforts du châssis, ce qui impose, dans la conception de l'aménagement du fourgon, une grande rigueur dans la gestion des espaces. Le rail utilisé par Store Van, fixé aux montants verticaux de l'atelier mobile, a une double fonction : solidariser de manière uniforme les rayonnages pour fourgons au châssis du véhicule et distribuer de manière homogène toutes les forces dynamiques auxquelles l'aménagement est soumis durant les déplacements.

Les étriers de fixation qui relient le rail au module présentent un dispositif articulé spécial qui amortit les vibrations causées par le déplacement du véhicule, en s'adaptant aux mouvements de torsion du châssis, en particulier dans les virages.

Grâce à ce système, nos aménagements pour fourgons peuvent être conçus avec la plus grande liberté, mais dans le respect de standards de sécurité, de stabilité et de durée élevés.

Tous nos systèmes de fixation peuvent bénéficier de systèmes d'accrochage/déaccrochage rapide des modules au moyen de poignées de serrage à cliquet qui permettent de démonter l'aménagement sans utiliser d'outils. Le rayonnage de votre atelier mobile peut ainsi être déclaré comme matériel transporté ou comme dispositif de sécurité du chargement fixé au véhicule de manière non permanente, conformément aux dispositions de la directive 2014/47 UE, chapitre 1, article 3, paragraphe 5.



CERTIFICAZIONI

CERTIFICATIONS

PRODUZIONE CERTIFICATA

- Certificati ISO 9001:2015.
- Superata brillantemente la prova di CRASH TEST eseguita secondo le ultime normative europee ECE-R17 con impatto a 50 Km/h.
- Certificazione GS per l'arredo interno e le rampe di carico.
- Certificazione GS per il portatutto-portascale.

PRODUCTION CERTIFIÉE

- Certifiés ISO 9001:2015.
- ESSAI DE CHOC réalisé selon les normes européennes ECE-R17 les plus récentes avec impact à 50 km/h, passé brillamment.
- Certification GS pour l'aménagement interne et les rampes de chargement.
- Certification GS pour les galeries de toit et porte-échelles.

CRASH TEST
ECE-R17





Fiat *Ducato*
Peugeot *Boxer*
Citroën *Jumper*

14

Renault *Master*
Opel *Movano*
Nissan *NV400*

20

Volkswagen *Crafter*
Man *Tge*

24

Ford *Transit*

28

Mercedes-Benz *Sprinter*

32

LIGHT SHELF

LIGHT SHELF

FURGONE LAMIERATO - FOURGON TÔLÉ





RIPIANI RIBALTABILI PER CORRIERI ESPRESSI (CEP), SPEDIZIONIERI, FURGONI AMBULANTI.

Per l'allestimento di corrieri espressi, come GLS – DHL – UPS – SDA, professionisti delle consegne di pacchetti dell'ultimo miglio, o per le piccole aziende di servizio trasporto di materiale imballato, Store Van presenta **Light Shelf**, la linea di **ripiani ribaltabili per furgoni** di terza generazione.

I ripiani **Light Shelf** sono testati da diversi anni su migliaia di veicoli utilizzati da corrieri espressi con ottimi risultati in termini di robustezza e affidabilità.

Disponibili in **diverse lunghezze** e **configurabili** a seconda delle esigenze del cliente, questi ripiani richiudibili permettono di ottimizzare e aumentare notevolmente la capacità di carico del furgone. Il sistema con ripiani ribaltabili **Light Shelf** può ospitare **fino a 6 mensole in altezza** e, per trasportare in totale sicurezza la merce, permette l'integrazione di guide "airline" per l'ancoraggio della carico tramite cinghie e barre fermacarico.

ÉTAGÈRES PLIABLES POUR COURSIERS EXPRESS (CEP), LIVREURS, CAMIONS AMBULANTS.

Pour l'aménagement des coursiers express, tels que GLS - DHL - UPS - SDA, les professionnels des livraisons de colis de renommée internationale, ou les petites entreprises de transport pour le matériel emballé, Store Van présente **Light Shelf**, la ligne d'**étagères pliables pour les véhicules utilitaires** de troisième génération.

Les étagères **Light Shelf** sont testées depuis plusieurs années sur des milliers de véhicules utilisés par les coursiers express avec d'excellents résultats en termes de robustesse et fiabilité. Disponibles en **différentes longueurs et réglables selon les exigences** du client, ces étagères repliables permettent d'optimiser et d'augmenter de manière significative la capacité de chargement du véhicule utilitaire.

Le système d'étagères pliables **Light Shelf** peut accueillir **jusqu'à 6 planches en hauteur** et, pour transporter les marchandises en toute sécurité, permet d'intégrer des glissières "airline" pour arrimer la charge à l'aide de sangles et de barres de charge.



LIGHT SHELF

LIGHT SHELF

FURGONE LAMIERATO - FOURGON TÔLÉ





CARATTERISTICHE DEI RIPIANI

Progettata per trasportare **contenitori e cassette con misure standard europee** (400x300 mm e 600x400 mm), la linea di ripiani per furgoni **Light Shelf** risponde perfettamente anche alle esigenze richieste nel trasporto di ricambi per veicoli, elettrodomestici, posaterie e stoviglie per servizi di catering, ecc. La chiusura completa o parziale dei ripiani rende possibile anche il **trasporto di merce voluminosa su europallet**.

Light Shelf utilizza come blocco di sicurezza un apposito perno che permette l'**apertura della mensola con una sola mano**. La portata di ogni mensola è di **80 kg** con la possibilità di aumentarla fino a 120 kg grazie all'utilizzo di appositi montanti. Il sistema di sospensione dei ripiani Light Shelf **non necessita di fili in acciaio o cinghie**, che fungono spesso da impedimenti per l'organizzazione longitudinale dei pacchetti. Questo permette di trasformare più mensole allineate alla stessa altezza in un unico piano di carico, rendendo facile il **trasporto di merce particolarmente lunga**.

CARACTÉRISTIQUES DES ÉTAGÈRES

Conçue pour transporter des **conteneurs et des caisses aux dimensions standard européennes** (400 x 300 mm et 600 x 400 mm), la ligne d'étagères pour véhicules utilitaires **Light Shelf** répond parfaitement notamment aux exigences requises dans le transport de pièces détachées pour véhicules, d'appareils électroménagers, de couverts et de vaisselle pour les services de traiteur, etc. La fermeture complète ou partielle des étagères permet également de **transporter des marchandises volumineuses sur europallettes**.

Light Shelf utilise comme dispositif de sécurité un taquet spécial qui permet d'**ouvrir la planche d'une main**. La capacité de chaque planche est de 80 kg avec la possibilité de l'**augmenter jusqu'à 120 kg** grâce à l'utilisation de montants spéciaux. Le système de suspension des étagères Light Shelf **n'a pas besoin de fils en acier ni de sangles**, qui constituent souvent des obstacles à l'organisation longitudinale des emballages. Cela permet de transformer plusieurs planches alignées à la même hauteur en un seul plan de charge, facilitant le **transport de marchandises particulièrement longues**.



Mensola chiusa in posizione 1
Étagère fermée en position 1



Mensola chiusa in posizione 2
Étagère fermée en position 2



Mensola aperta
Étagère ouverte

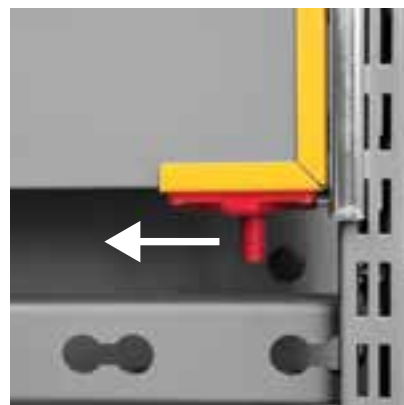

Apertura della mensola con una sola mano
Ouverture de l'étagère d'une main

LIGHT SHELF

LIGHT SHELF

FURGONE LAMIERATO - FOURGON TÔLÉ





VANTAGGI DEL SISTEMA DI RIPIANI RIBALTABILI PER FURGONI LIGHT SHELF:

- Fino 6 ripiani in altezza;
- Chiusura completa o parziale;
- Portata fino a 120 kg;
- Sistema di sospensione **senza** fili in acciaio o cinghie;
- Ideale per il trasporto merce lunga;
- Compatibile con contenitori con misure standard europee.
- Foratura su tutte le mensole per alloggiamento e fissaggio divisori standard in alluminio h 50 mm o divisori ad arco h 300 mm.
- Possibilità di regolare le mensole o aggiungerle in altezza a passo 38 mm grazie alle staffe laterali ad incastro sui montati forati.
- Assenza di spigoli vivi su tutti i bordi e i fori.
- Verniciatura delle mensole ad immersione CATAFORESI (tecnologia diffusa nel settore automobilistico) in grado di conferire una migliore resistenza alla corrosione e agli agenti chimici rispetto alla tradizionale verniciatura con fosfosgrassaggio e polvere poliestere.
- Possibilità di inserire tappetini antiscivolo.

AVANTAGES DU SYSTÈME D'ÉTAGÈRES PLIABLES POUR VÉHICULES UTILITAIRES LIGHT SHELF:

- 6 étagères en hauteur ;
- Fermeture complète ou partielle ;
- Portée maximale 120 kg ;
- Système de suspension en acier **sans** fils ni sangles ;
- Idéale pour les longs transports de marchandises ;
- Compatible avec les conteneurs de tailles standard européennes ;
- Perçage sur toutes les planches pour le logement et la fixation des séparateurs standard en aluminium h 50 mm ou diviseurs voutés h 300 mm ;
- Possibilité d'ajuster les planches ou de les monter de 38 mm de plus grâce aux supports latéraux encastrés sur les montants percés ;
- Aucune aspérité sur les bords et les trous ;
- Peinture des étagères à immersion CATAFORESI (technologie diffuse dans le secteur automobile) capable de mieux résister à la corrosion et aux agents chimiques par rapport à la peinture traditionnelle avec phospho-dégraissage et poudre polyester ;
- Possibilité d'insérer des tapis antidérapants.



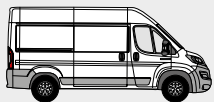

ESEMPI DI ALLESTIMENTO - EXEMPLES D'AMÉNAGEMENTS

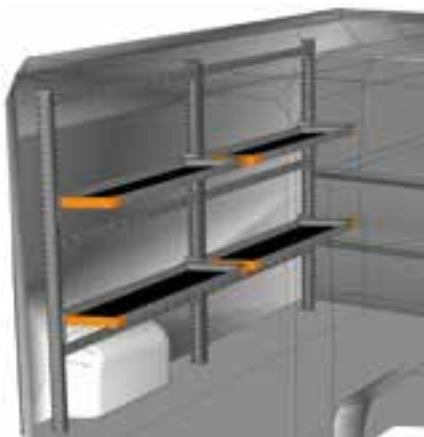

ESEMPIO - EXEMPLE

DU 2618 L1*

L=2620 P=430 H=1772 mm

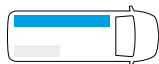

ESEMPIO - EXEMPLE

DU 2618 L2*

L=2620 P=430 H=1772 mm

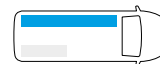

ESEMPIO - EXEMPLE

DU 2618 L3*

L=2620 P=430 H=1772 mm

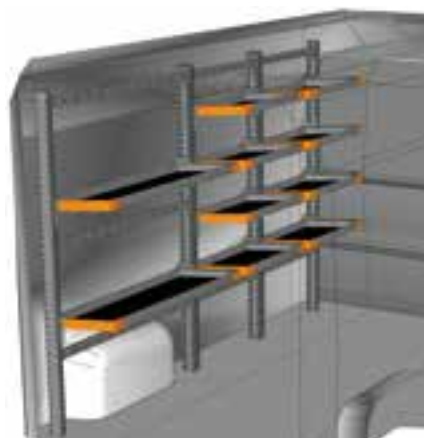
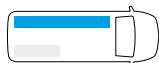

ESEMPIO - EXEMPLE

DU 2618 L4*

L=2659 P=430 H=1772 mm

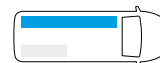

ESEMPIO - EXEMPLE

DU 1318 L1*

L=1310 P=430 H=1772 mm

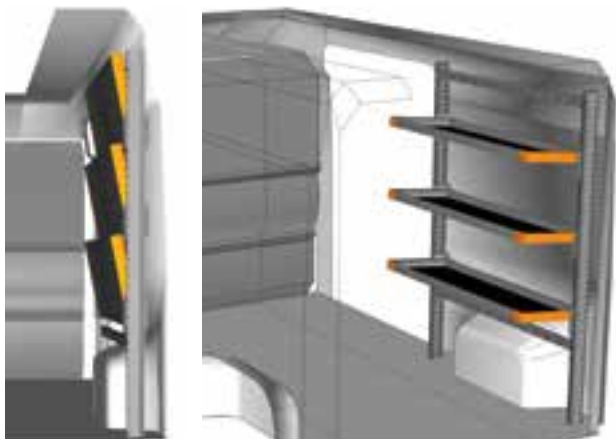

ESEMPIO - EXEMPLE

DU 1318 L2*

L=1310 P=430 H=1772 mm

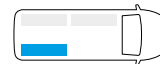

* Kit di montaggio in esclusiva del Distributore. Includere il manuale di istruzioni in dotazione.

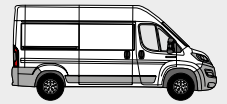

ESEMPI DI ALLESTIMENTO - EXEMPLES D'AMÉNAGEMENTS



ESEMPIO - EXEMPLE

EXAMPLE DU L2H2 L1 (*) (**)



1 x DU 2618 L4	3 x V18025 15
6 x 445D30	1 x B0X080
1 x DU 20G1 A0	1 x CPV080
1 x V22585	2 x V22136
6 x V22017	2 x V22124
2 x V18029 15	2 x V22148
1 x V18029 10	1 x YELLOW
6 x V22106	4 x V225820

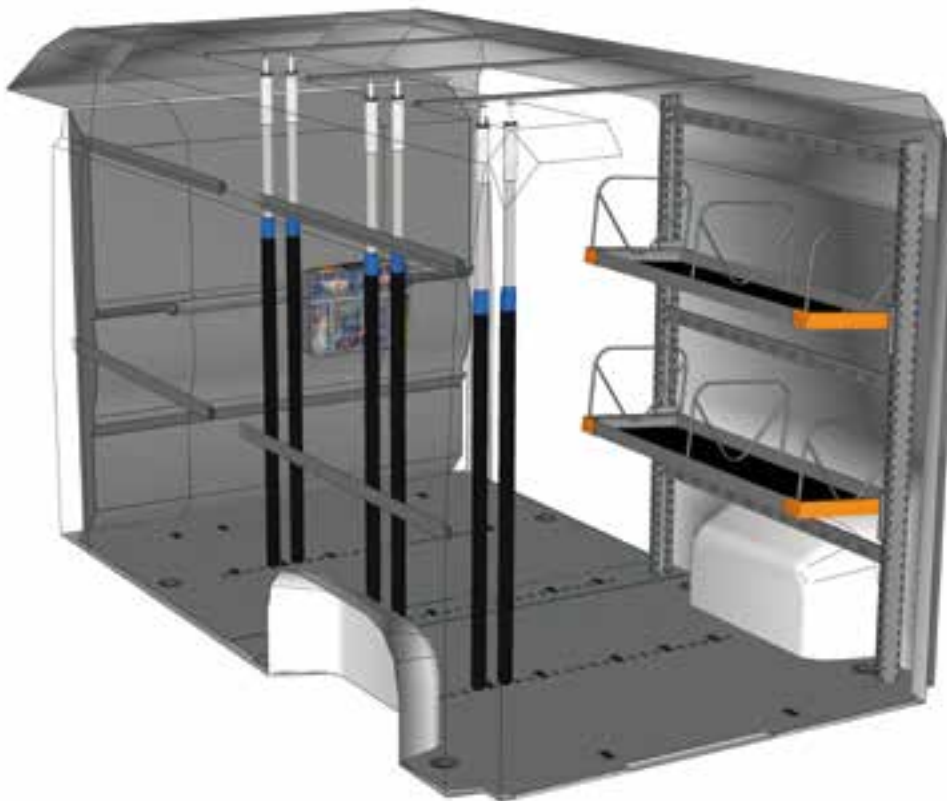

ESEMPIO - EXEMPLE

EXAMPLE DU L2H2 L2*



1 x DU 1318 L1	3 x V18025 15
6 x 445D30	1 x B0X080
1 x DU 20G1 A0	1 x CPV080
1 x V22585	2 x V22136
6 x V22017	2 x V22124
4 x V18029 15	2 x V22148
1 x V18029 10	1 x YELLOW
10 x V22106	4 x V225820

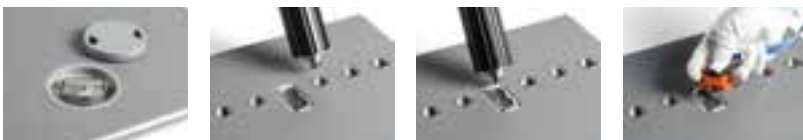

* Kit fissaggio incluso - Jeu de fixation inclus

** Contenitori esclusi - Bacs exclus

Non hai trovato il tuo allestimento?

Affidati ai nostri professionisti

Guarda il retro di questo catalogo e
contatta il punto Store Van piu vicino
oppure visita il nostro sito.

**Vous n'avez pas trouvé votre
équipement ? Confiez-vous
à nos professionnels**

Voir au dos de ce catalogue
et contactez le point StoreVan
le plus proche ou visitez notre site web.



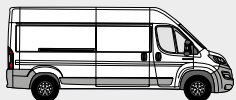

ESEMPI DI ALLESTIMENTO - EXEMPLES D'AMÉNAGEMENTS



ESEMPIO - EXEMPLE

DU 3218 L1*

L=3257 P=430 H=1772 mm

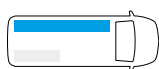

ESEMPIO - EXEMPLE

DU 3218 L2*

L=3257 P=430 H=1772 mm

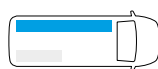

ESEMPIO - EXEMPLE

DU 3218 L3*

L=3252 P=430 H=1772 mm

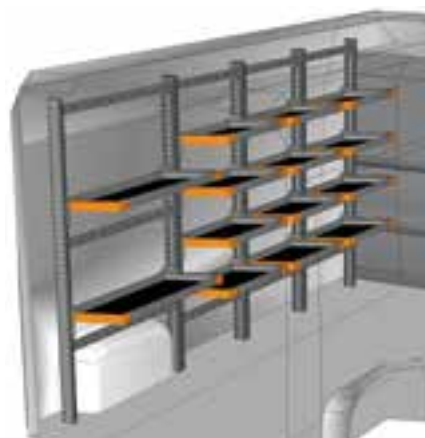
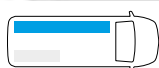

ESEMPIO - EXEMPLE

DU 3218 L4*

L=3167 P=430 H=1772 mm

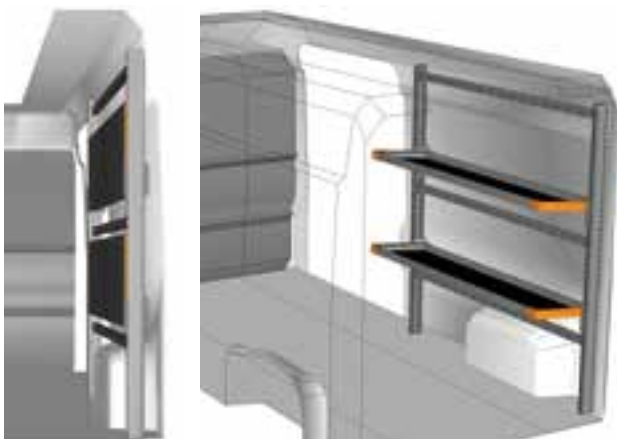
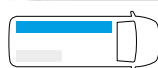

ESEMPIO - EXEMPLE

DU 1718 L1*

L=1733 P=430 H=1772 mm

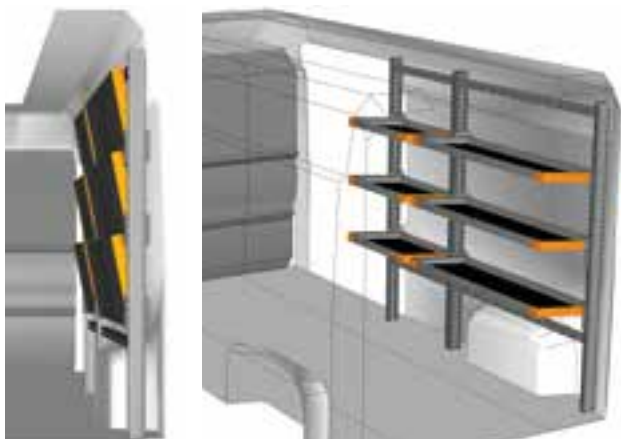
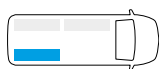

ESEMPIO - EXEMPLE

DU 2018 L1*

L=2027 P=430 H=1772 mm

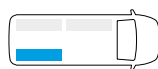

* Kit fissaggio incluso - Jeu de fixation inclus

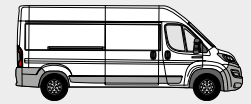

ESEMPI DI ALLESTIMENTO - EXEMPLES D'AMÉNAGEMENTS

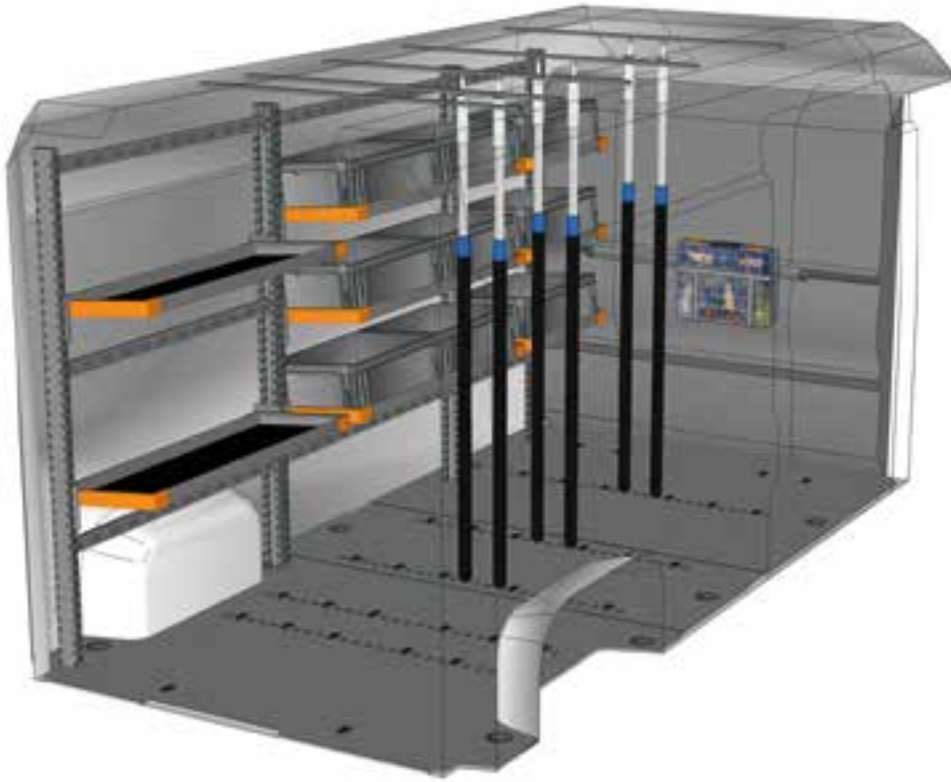

ESEMPIO - EXEMPLE

EXAMPLE DU L4H2 L1 (*) (**)



1 x DU 3218 L3	1 x BOX080
1 x DU 30G1 A0	1 x CPV080
1 x V22585	2 x V22136
6 x V22017	2 x V22124
2 x V18029 20	2 x V22148
1 x V18029 10	1 x YELLOW
6 x V22106	4 x V225820
5 x V18025 15	

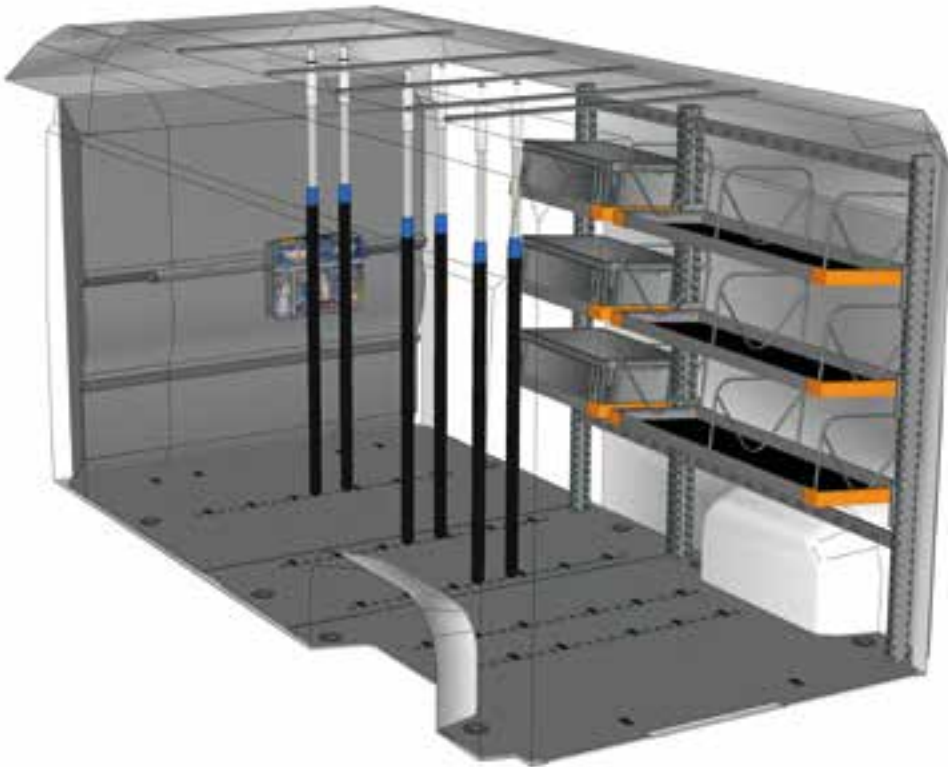

ESEMPIO - EXEMPLE

EXAMPLE DU L4H2 L2 (*) (**)



1 x DU 2018 L2	5 x V18025 15
9 x 445D30	1 x BOX080
1 x DU 30G1 A0	1 x CPV080
1 x V22585	2 x V22136
6 x V22017	2 x V22124
2 x V18029 15	2 x V22148
2 x V18029 20	1 x YELLOW
1 x V18029 10	4 x V225820
10 x V22106	

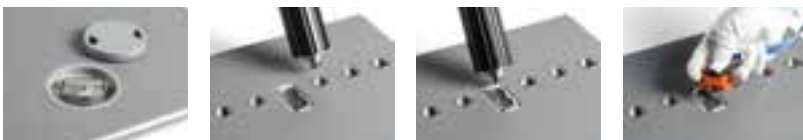

* Kit fissaggio incluso - Jeu de fixation inclus

** Contenitori esclusi - Bacs exclus

Non hai trovato il tuo allestimento?

Affidati ai nostri professionisti

Guarda il retro di questo catalogo e
contatta il punto Store Van piu vicino
oppure visita il nostro sito.

**Vous n'avez pas trouvé votre
équipement ? Confiez-vous
à nos professionnels**

Voir au dos de ce catalogue
et contactez le point StoreVan
le plus proche ou visitez notre site web.



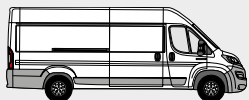

ESEMPI DI ALLESTIMENTO - EXEMPLES D'AMÉNAGEMENTS



ESEMPIO - EXEMPLE

DU 3518 L1*

L=3551 P=430 H=1772 mm

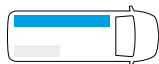

ESEMPIO - EXEMPLE

DU 3518 L2*

L=3551 P=430 H=1772 mm

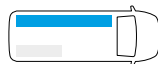

ESEMPIO - EXEMPLE

DU 3518 L3*

L=3551 P=430 H=1772 mm

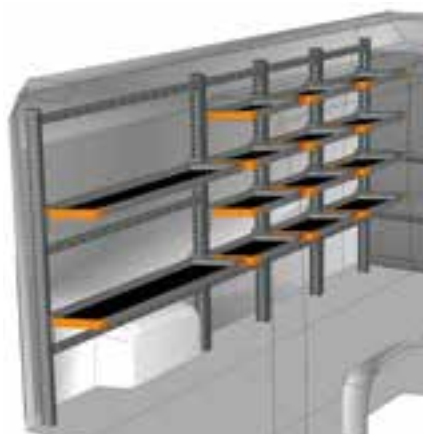
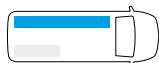

ESEMPIO - EXEMPLE

DU 3518 L4*

L=3675 P=430 H=1772 mm

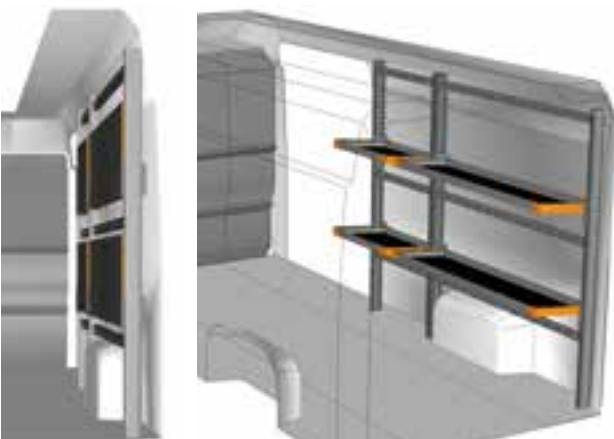
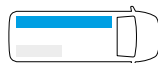

ESEMPIO - EXEMPLE

DU 2218 L1*

L=2241 P=430 H=1772 mm

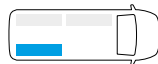
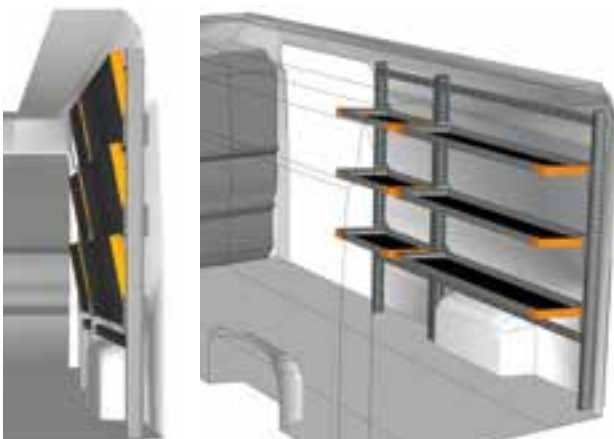

ESEMPIO - EXEMPLE

DU 2218 L2*

L=2241 P=430 H=1772 mm

* Kit fissaggio incluso - Jeu de fixation inclus

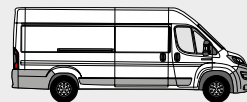

ESEMPI DI ALLESTIMENTO - EXEMPLES D'AMÉNAGEMENTS

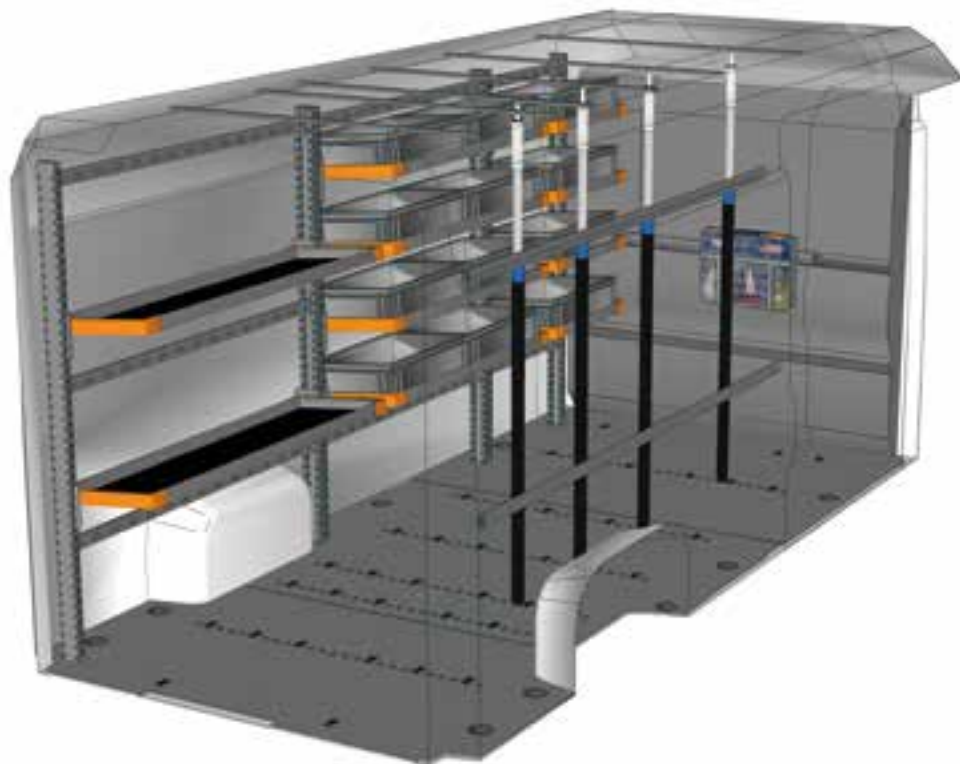

ESEMPIO - EXEMPLE

EXAMPLE DU L5H2 L1 (*) (**)



1 x DU 3518 L4	1 x BOX080
1 x DU 3LG1 A0	1 x CPV080
1 x V22585	2 x V22136
4 x V22017	2 x V22124
2 x V18029 25	2 x V22148
1 x V18029 10	1 x YELLOW
6 x V22106	4 x V225820
6 x V18025 15	

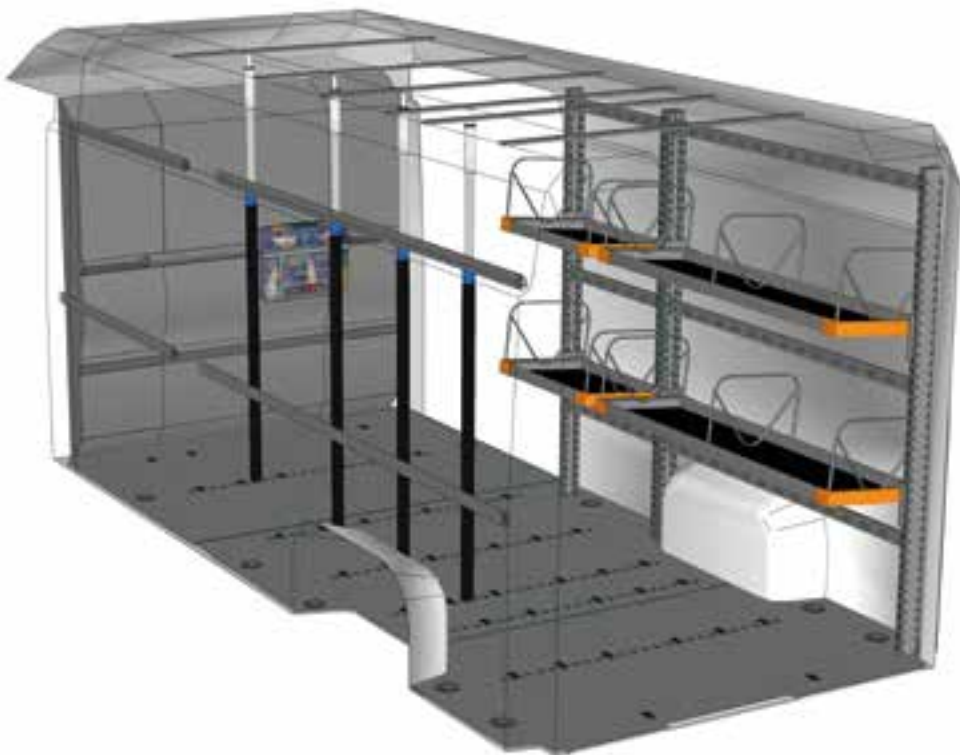

ESEMPIO - EXEMPLE

EXAMPLE DU L5H2 L2*



1 x DU 2218 L2	6 x V18025 15
10 x 445D30	1 x BOX080
1 x DU 3LG1 A0	1 x CPV080
1 x V22585	2 x V22136
4 x V22017	2 x V22124
2 x V18029 15	2 x V22148
2 x V18029 25	1 x YELLOW
1 x V18029 10	4 x V225820
10 x V22106	

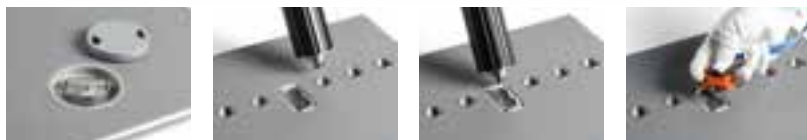

* Kit fissaggio incluso - Jeu de fixation inclus

** Contenitori esclusi - Bacs exclus

Non hai trovato il tuo allestimento?
Affidati ai nostri professionisti
Guarda il retro di questo catalogo e
contatta il punto Store Van piu vicino
oppure visita il nostro sito.

**Vous n'avez pas trouvé votre
équipement ? Confiez-vous
à nos professionnels**
Voir au dos de ce catalogue
et contactez le point StoreVan
le plus proche ou visitez notre site web.



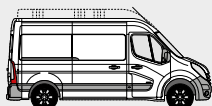

ESEMPI DI ALLESTIMENTO - EXEMPLES D'AMÉNAGEMENTS

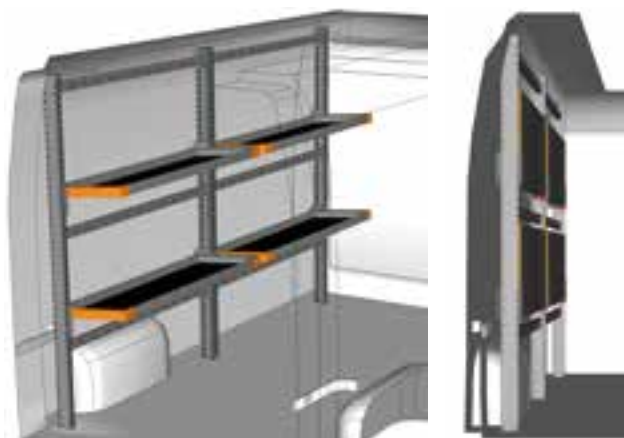

ESEMPIO - EXEMPLE

MA 2618 L1*

L=2620 P=430 H=1772 mm

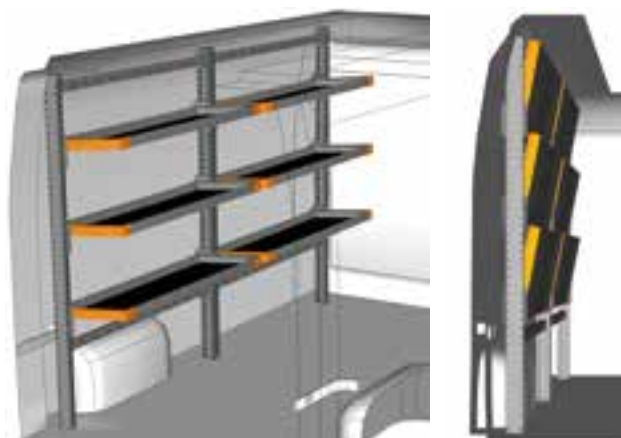
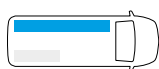

ESEMPIO - EXEMPLE

MA 2618 L2*

L=2620 P=430 H=1772 mm

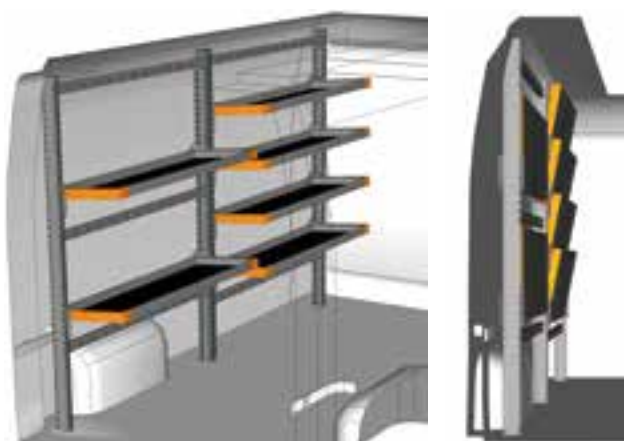
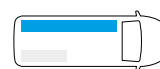

ESEMPIO - EXEMPLE

MA 2618 L3*

L=2620 P=430 H=1772 mm

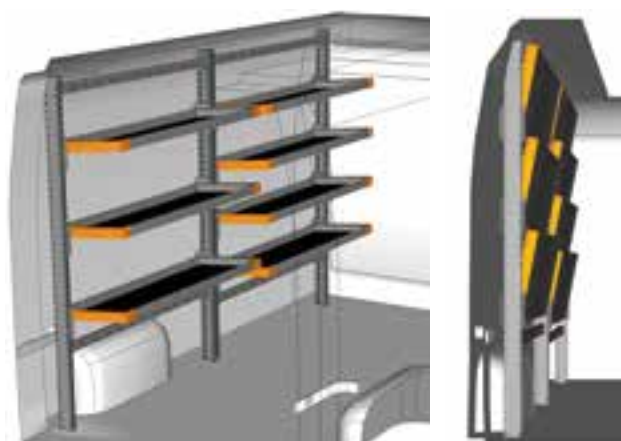
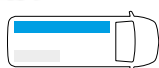

ESEMPIO - EXEMPLE

MA 2618 L4*

L=2620 P=430 H=1772 mm

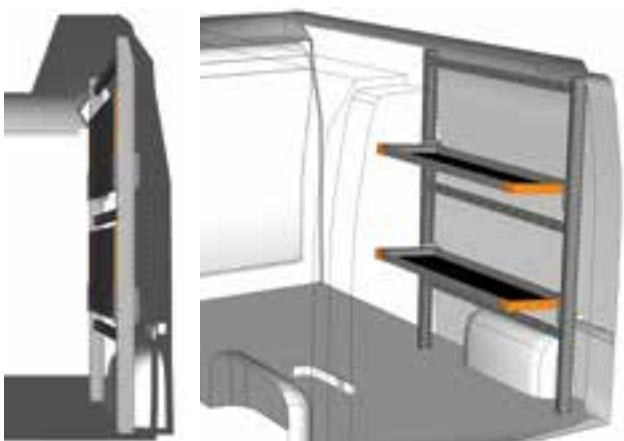
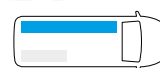

ESEMPIO - EXEMPLE

MA 1318 L1*

L=1310 P=430 H=1772 mm

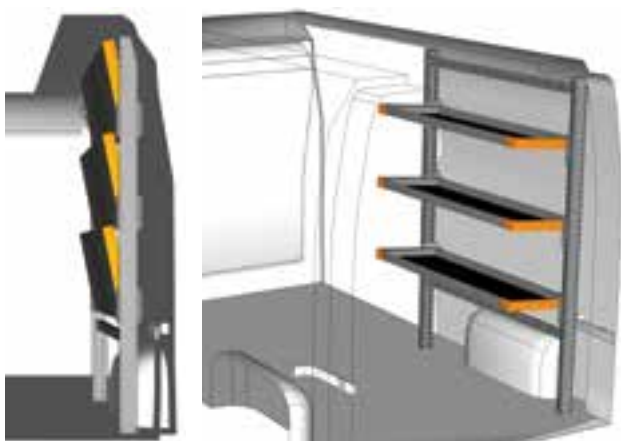
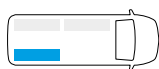

ESEMPIO - EXEMPLE

MA 1318 L2*

L=1310 P=430 H=1772 mm

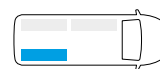

* Kit fissaggio incluso - Jeu de fixation inclus

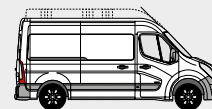

ESEMPI DI ALLESTIMENTO - EXEMPLES D'AMÉNAGEMENTS

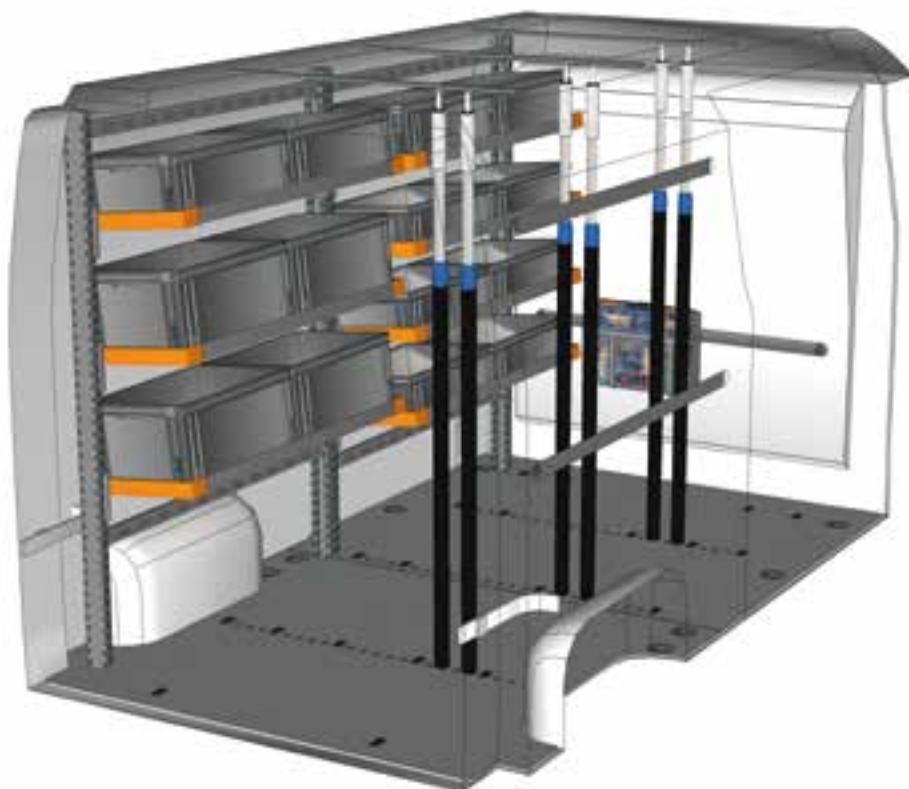

ESEMPIO - EXEMPLE

EXAMPLE MA L2H2 L1 (*) (**)



1 x MA 2618 L4	1 x BOX080
1 x MA 20G1 A0	1 x CPV080
1 x V22585	2 x V22136
6 x V22017	2 x V22124
3 x V18029 15	2 x V22148
6 x V22106	1 x YELLOW
3 x V18025 15	4 x V225820

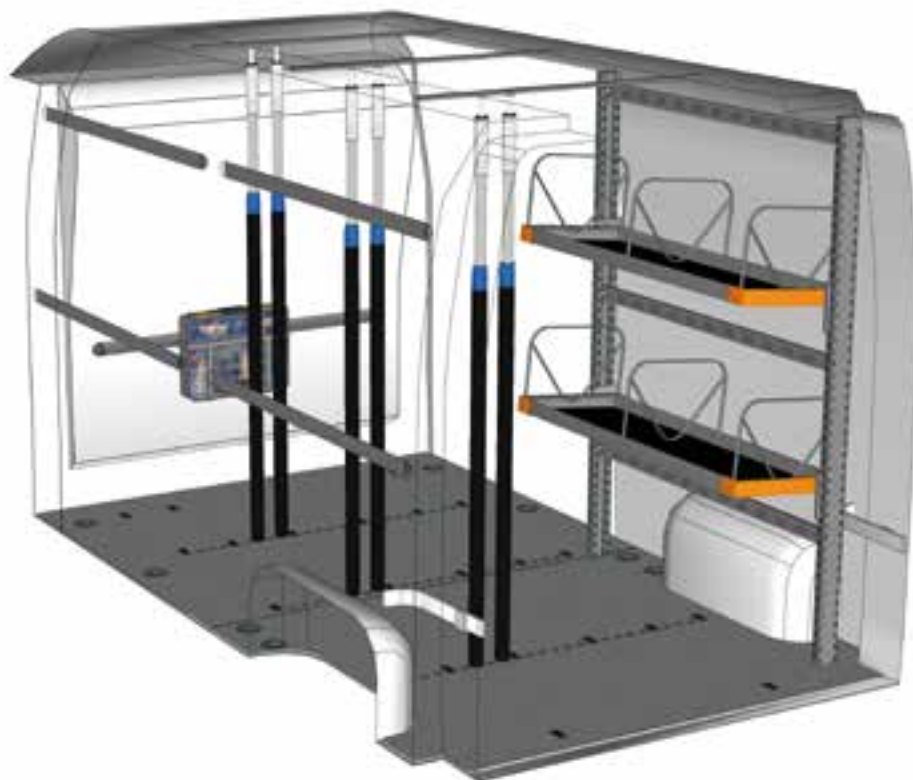

ESEMPIO - EXEMPLE

EXAMPLE MA L2H2 L2*



1 x MA 1318 L1	1 x BOX080
6 x 445D30	1 x CPV080
1 x MA 20G1 A0	2 x V22136
1 x V22585	2 x V22124
6 x V22017	2 x V22148
5 x V18029 15	1 x YELLOW
10 x V22106	4 x V225820
3 x V18025 15	

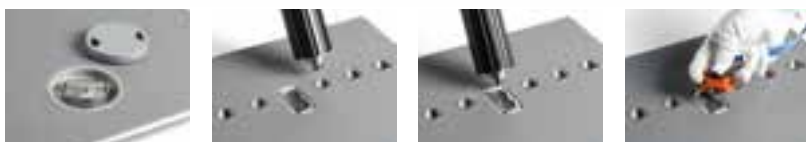

* Kit fissaggio incluso - Jeu de fixation inclus

** Contenitori esclusi - Bacs exclus

Non hai trovato il tuo allestimento?
Affidati ai nostri professionisti
Guarda il retro di questo catalogo e
contatta il punto Store Van piu vicino
oppure visita il nostro sito.

**Vous n'avez pas trouvé votre
équipement ? Confiez-vous
à nos professionnels**
Voir au dos de ce catalogue
et contactez le point StoreVan
le plus proche ou visitez notre site web.



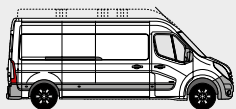

ESEMPI DI ALLESTIMENTO - EXEMPLES D'AMÉNAGEMENTS

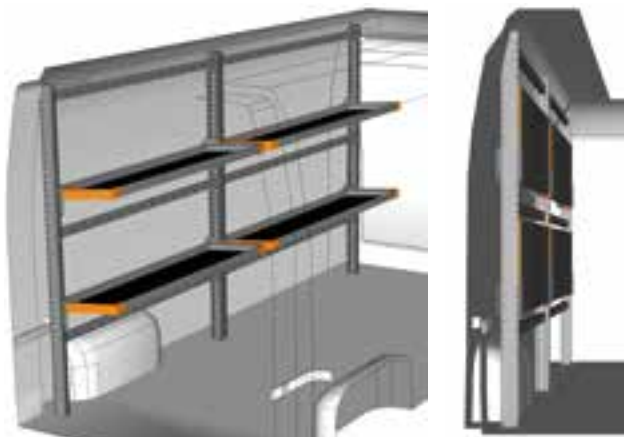

ESEMPIO - EXEMPLE

MA 3218 L1*

L=3257 P=430 H=1772 mm

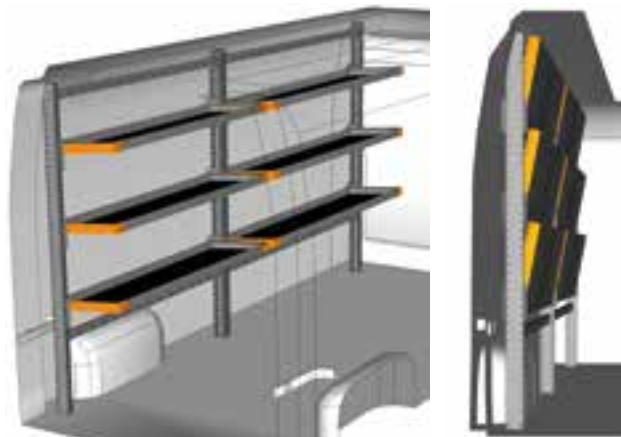
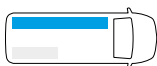

ESEMPIO - EXEMPLE

MA 3218 L2*

L=3257 P=430 H=1772 mm

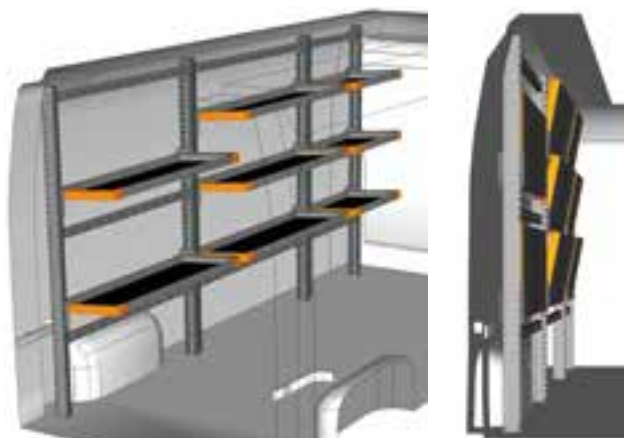
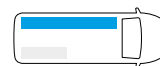

ESEMPIO - EXEMPLE

MA 3218 L3*

L=3252 P=430 H=1772 mm

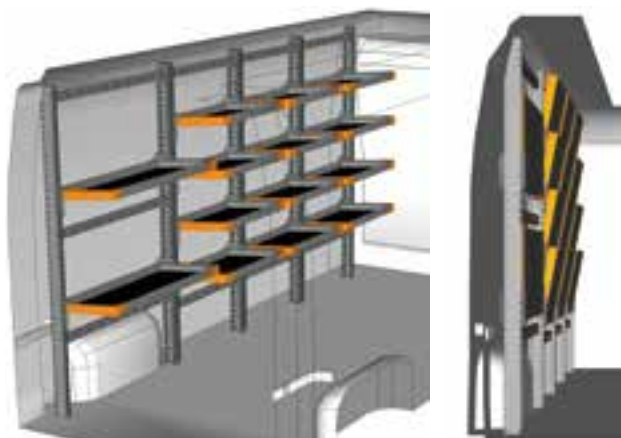
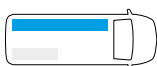

ESEMPIO - EXEMPLE

MA 3218 L4*

L=3167 P=430 H=1772 mm

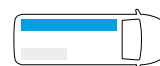

ESEMPIO - EXEMPLE

MA 2018 L1*

L=2027 P=430 H=1772 mm

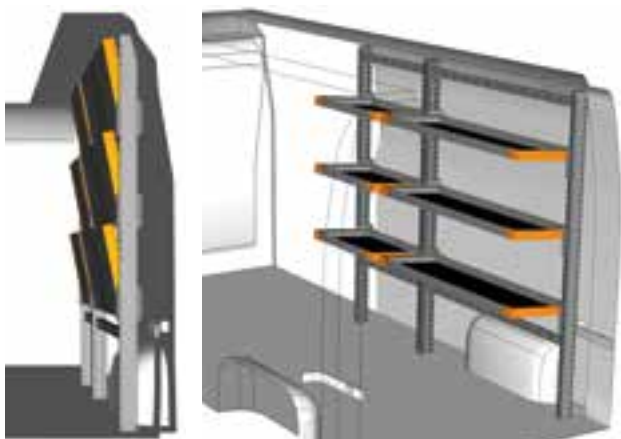
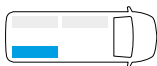

ESEMPIO - EXEMPLE

MA 2018 L2*

L=2027 P=430 H=1772 mm

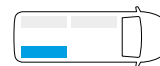

* Kit fissaggio incluso - Jeu de fixation inclus

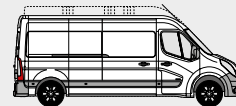

ESEMPI DI ALLESTIMENTO - EXEMPLES D'AMÉNAGEMENTS

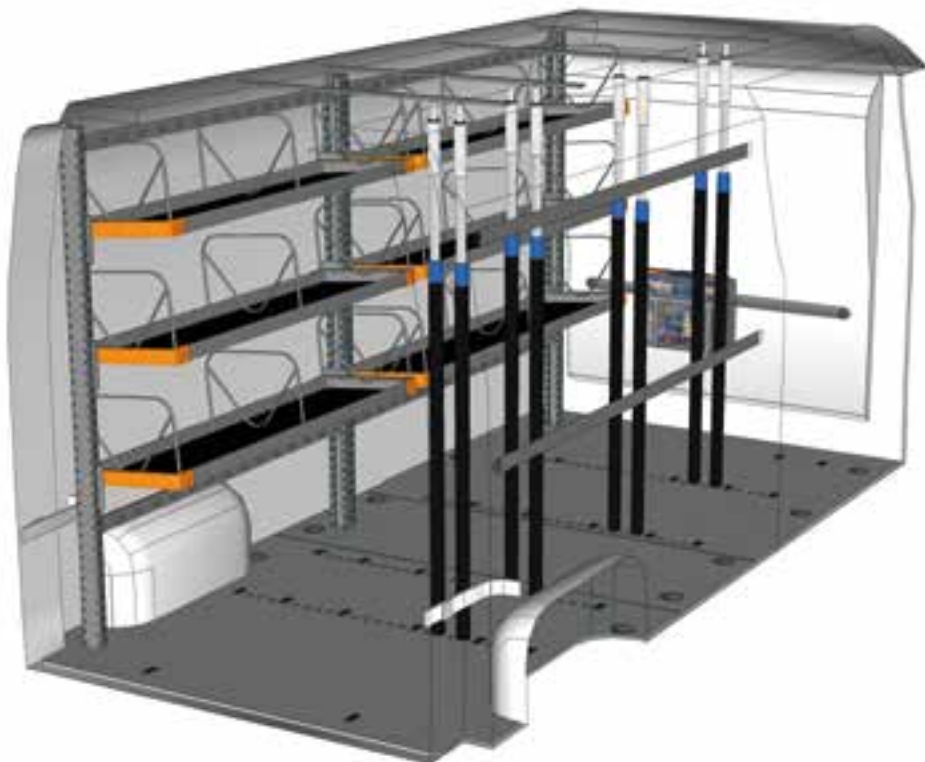

ESEMPIO - EXEMPLE

EXAMPLE MA L3H2 L1*



1 x MA 3218 L2	4 x V18025 15
18 x 445D30	1 x BOX080
1 x MA 30G1 A0	1 x CPV080
1 x V22585	2 x V22136
8 x V22017	2 x V22124
1 x V18029 15	2 x V22148
2 x V18029 20	1 x YELLOW
6 x V22106	4 x V225820

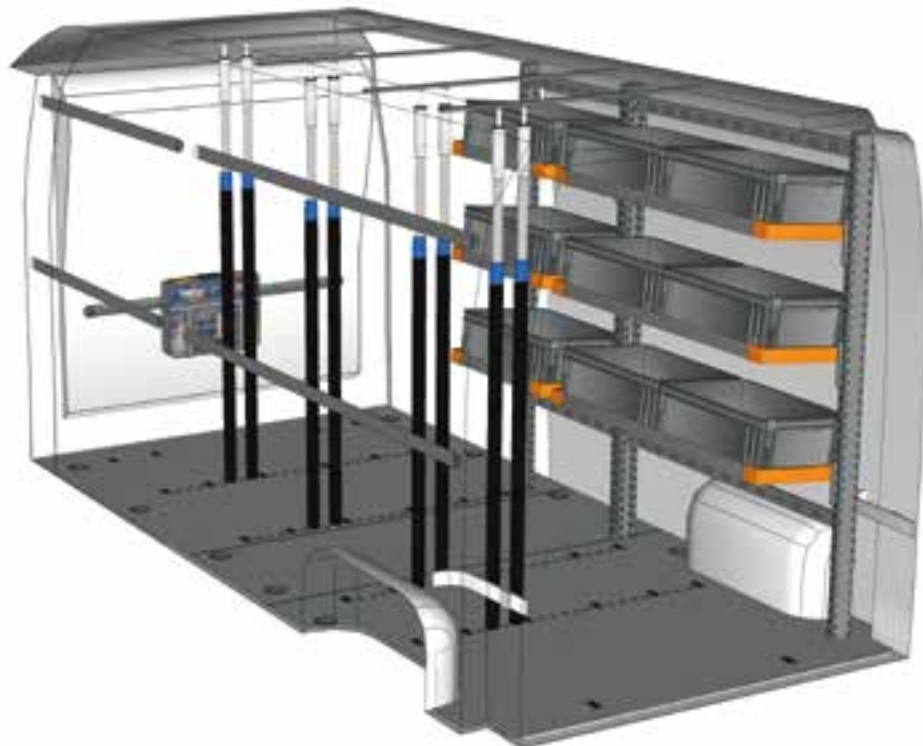

ESEMPIO - EXEMPLE

EXAMPLE MA L3H2 L2>(*)(**)



1 x MA 2018 L2	1 x BOX080
1 x MA 30G1 A0	1 x CPV080
1 x V22585	2 x V22136
8 x V22017	2 x V22124
3 x V18029 15	2 x V22148
2 x V18029 20	1 x YELLOW
10 x V22106	4 x V225820
4 x V18025 15	



* Kit fissaggio incluso - Jeu de fixation inclus

** Contenitori esclusi - Bacs exclus

Non hai trovato il tuo allestimento?
Affidati ai nostri professionisti
Guarda il retro di questo catalogo e
contatta il punto Store Van piu vicino
oppure visita il nostro sito.

**Vous n'avez pas trouvé votre
équipement ? Confiez-vous
à nos professionnels**
Voir au dos de ce catalogue
et contactez le point StoreVan
le plus proche ou visitez notre site web.



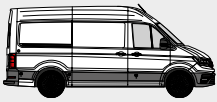

ESEMPI DI ALLESTIMENTO - EXEMPLES D'AMÉNAGEMENTS



ESEMPIO - EXEMPLE

CR 2818 L1*

L=2834 P=430 H=1772 mm

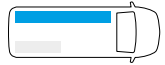

ESEMPIO - EXEMPLE

CR 2818 L2*

L=2834 P=430 H=1772 mm

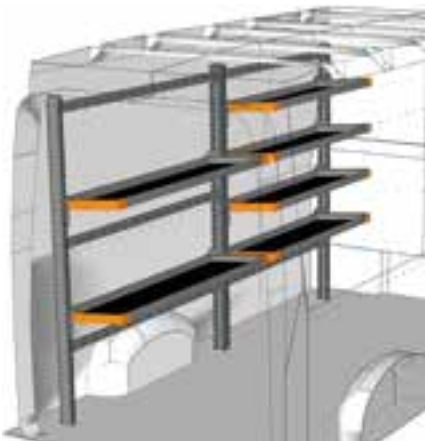

ESEMPIO - EXEMPLE

CR 2818 L3*

L=2834 P=430 H=1772 mm

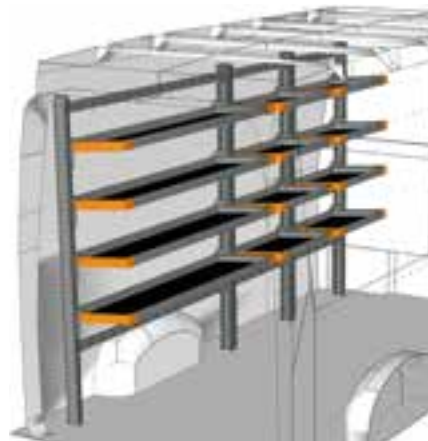
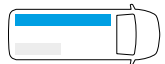

ESEMPIO - EXEMPLE

CR 2818 L4*

L=2958 P=430 H=1772 mm

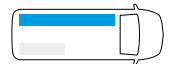

ESEMPIO - EXEMPLE

CR 1518 L1*

L=1524 P=430 H=1772 mm

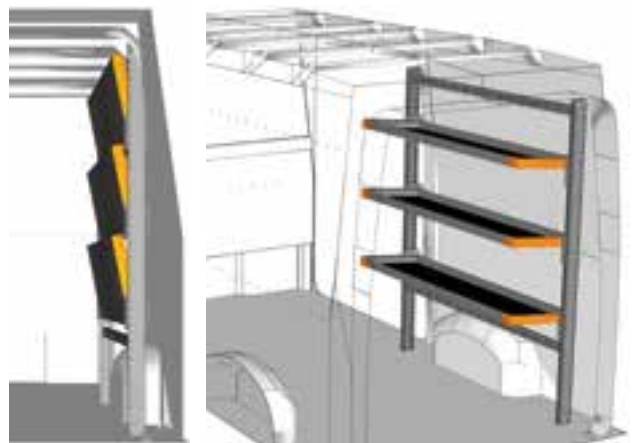
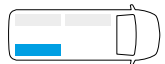

ESEMPIO - EXEMPLE

CR 1518 L2*

L=1524 P=430 H=1772 mm



* Kit fissaggio incluso - Jeu de fixation inclus

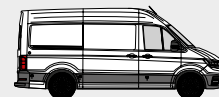

ESEMPI DI ALLESTIMENTO - EXEMPLES D'AMÉNAGEMENTS

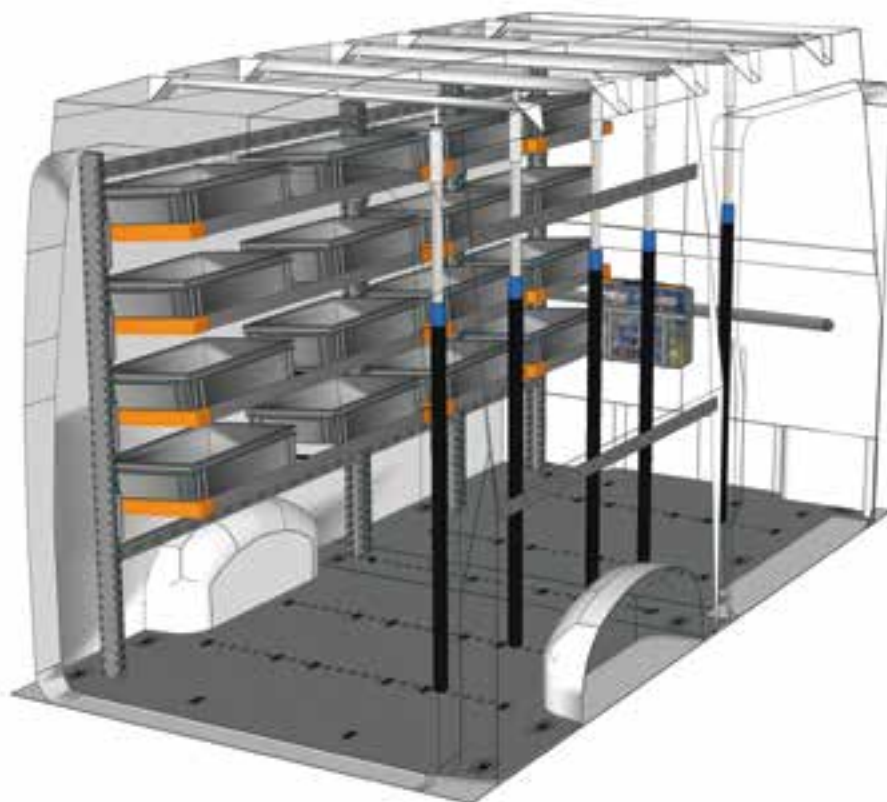

ESEMPIO - EXEMPLE

EXAMPLE CR L3H3 L1 (*) (**)



1 x CR 2818 L4	1 x BOX080
8 x 445D05	1 x CPV080
1 x CR 30G1 A0	2 x V22136
1 x V22585	2 x V22124
5 x V22017	2 x V22148
3 x V18029 15	1 x YELLOW
2 x V22106	4 x V225820
5 x V18025 15	

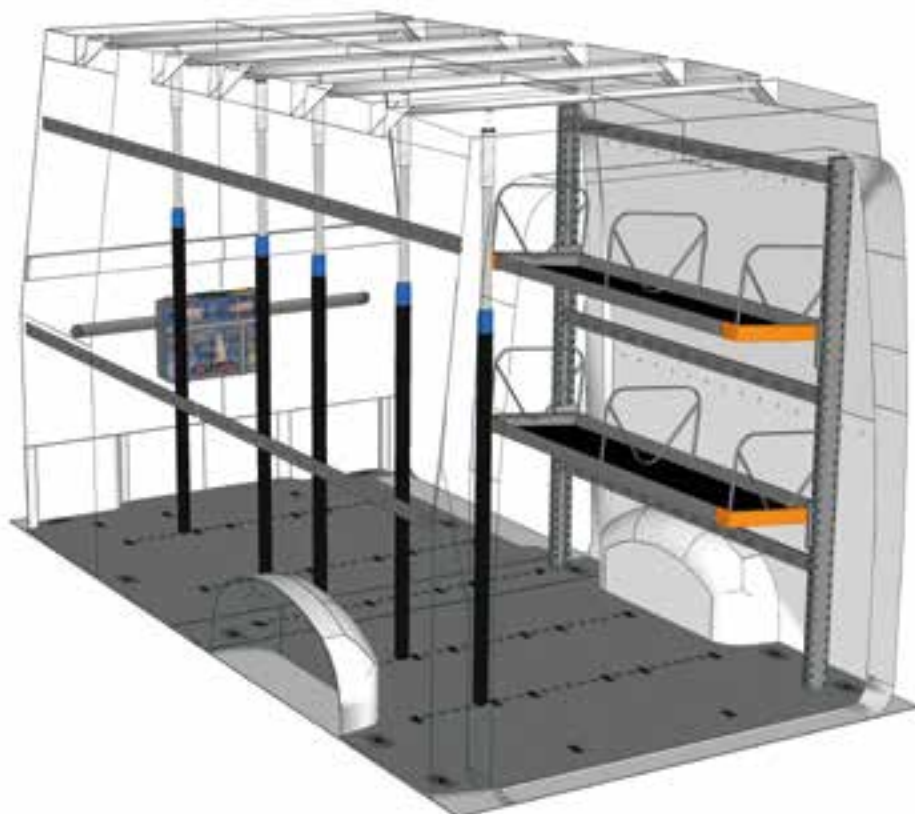

ESEMPIO - EXEMPLE

EXAMPLE CR L3H3 L2*



1 x CR 1518 L1	1 x BOX080
6 x 445D30	1 x CPV080
1 x CR 30G1 A0	2 x V22136
1 x V22585	2 x V22124
5 x V22017	2 x V22148
5 x V18029 15	1 x YELLOW
2 x V22106	4 x V225820
5 x V18025 15	



* Kit fissaggio incluso - Jeu de fixation inclus

** Contenitori esclusi - Bacs exclus

**Non hai trovato il tuo allestimento?
Affidati ai nostri professionisti**

Guarda il retro di questo catalogo e
contatta il punto Store Van piu vicino
oppure visita il nostro sito.

**Vous n'avez pas trouvé votre
équipement ? Confiez-vous
à nos professionnels**

Voir au dos de ce catalogue
et contactez le point StoreVan
le plus proche ou visitez notre site web.



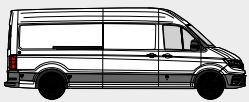

ESEMPI DI ALLESTIMENTO - EXEMPLES D'AMÉNAGEMENTS



ESEMPIO - EXEMPLE

CR 3718 L1*

L=3765 P=430 H=1772 mm

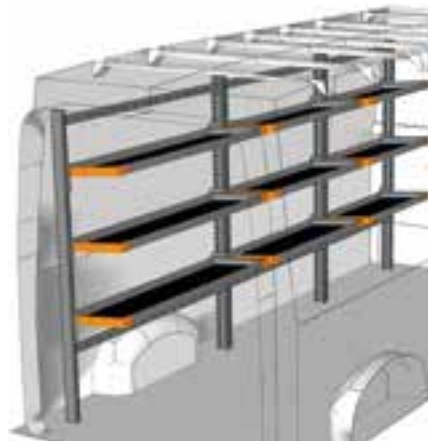
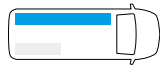

ESEMPIO - EXEMPLE

CR 3718 L2*

L=3765 P=430 H=1772 mm

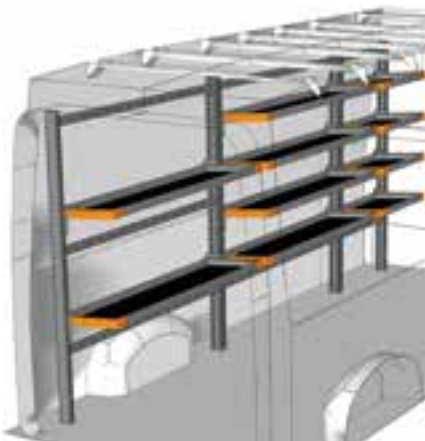
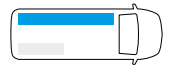

ESEMPIO - EXEMPLE

CR 3718 L3*

L=3765 P=430 H=1772 mm

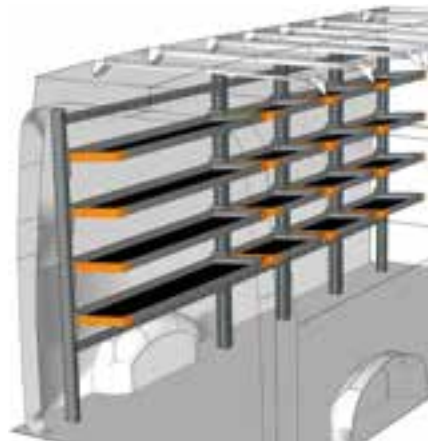
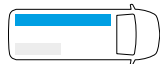

ESEMPIO - EXEMPLE

CR 3718 L4*

L=3675 P=430 H=1772 mm

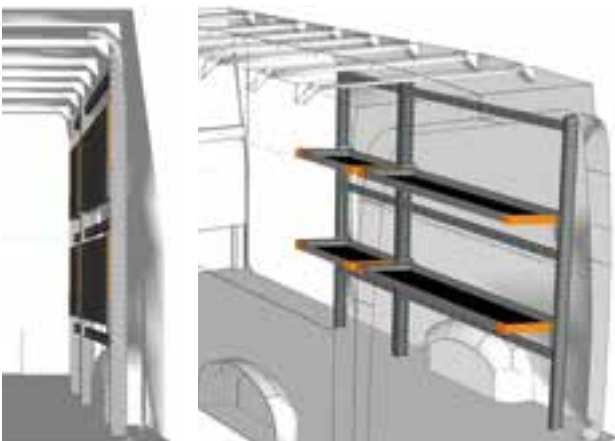
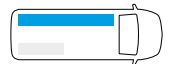

ESEMPIO - EXEMPLE

CR 2218 L1*

L=2241 P=430 H=1772 mm

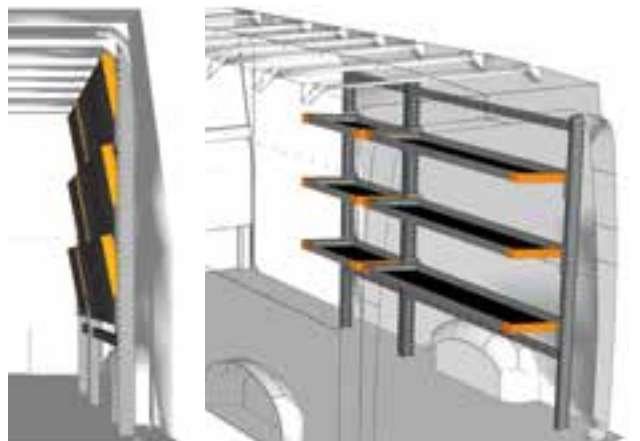

ESEMPIO - EXEMPLE

CR 2218 L2*

L=2241 P=430 H=1772 mm



* Kit fissaggio incluso - Jeu de fixation inclus

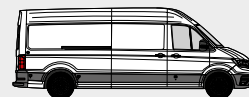

ESEMPI DI ALLESTIMENTO - EXEMPLES D'AMÉNAGEMENTS

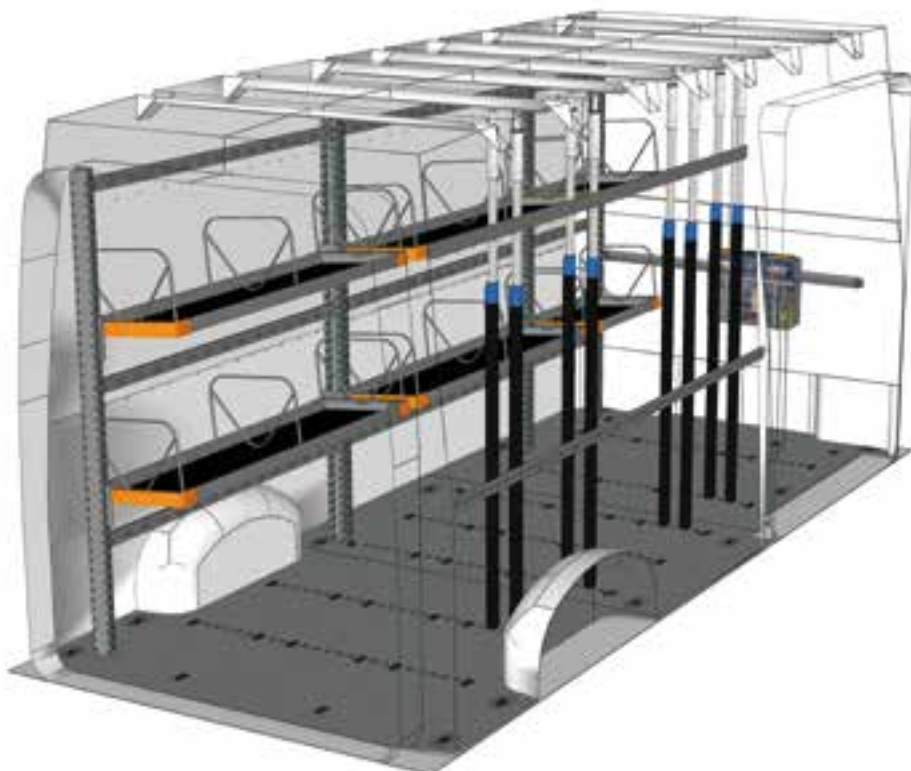

ESEMPIO - EXEMPLE

EXAMPLE CR L4H3 L1*



1 x CR 3718 L1	7 x V18025 15
16 x 445D30	1 x B0X080
1 x CR 40G1 A0	1 x CPV080
1 x V22585	2 x V22136
8 x V22017	2 x V22124
1 x V18029 15	2 x V22148
2 x V18029 25	1 x YELLOW
2 x V22106	4 x V225820

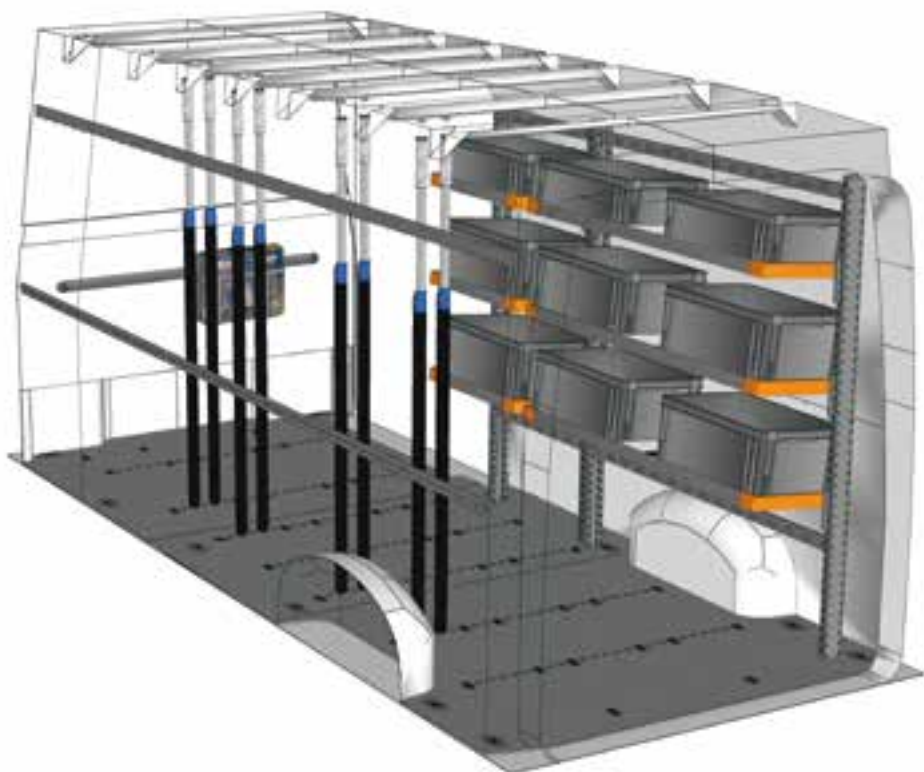

ESEMPIO - EXEMPLE

EXAMPLE CR L4H3 L2*(**)



1 x CR 2218 L2	7 x V18025 15
6 x 445D05	1 x B0X080
1 x CR 40G1 A0	1 x CPV080
1 x V22585	2 x V22136
8 x V22017	2 x V22124
3 x V18029 15	2 x V22148
2 x V18029 25	1 x YELLOW
2 x V22106	4 x V225820



* Kit fissaggio incluso - Jeu de fixation inclus

** Contenitori esclusi - Bacs exclus

Non hai trovato il tuo allestimento?

Affidati ai nostri professionisti

Guarda il retro di questo catalogo e
contatta il punto Store Van piu vicino
oppure visita il nostro sito.

**Vous n'avez pas trouvé votre
équipement ? Confiez-vous
à nos professionnels**

Voir au dos de ce catalogue
et contactez le point StoreVan
le plus proche ou visitez notre site web.





ESEMPIO DI ALLESTIMENTO - EXEMPLES D'AMÉNAGEMENTS

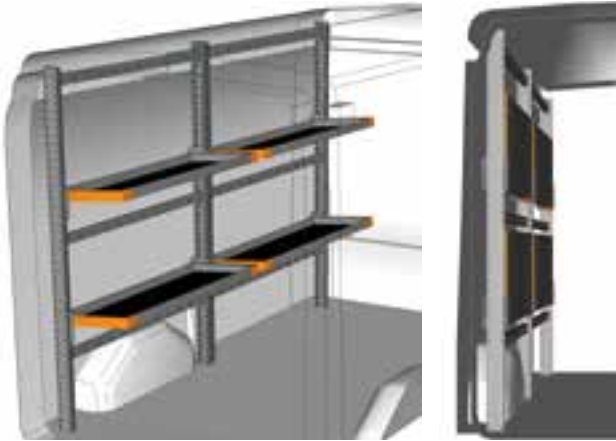

ESEMPIO - EXEMPLE

TR 2518 L1*

L=2535 P=430 H=1772 mm

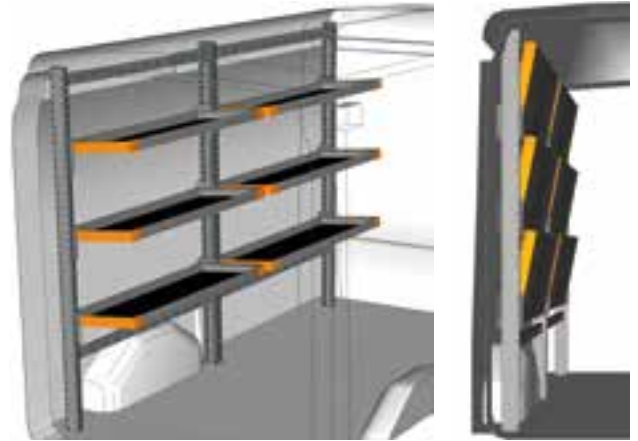
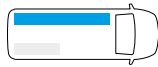

ESEMPIO - EXEMPLE

TR 2518 L2*

L=2535 P=430 H=1772 mm

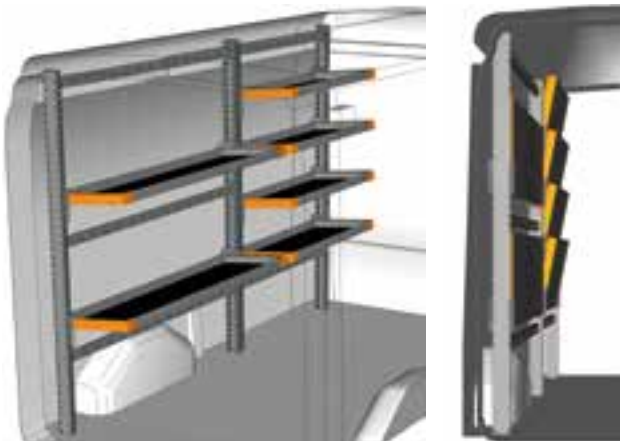

ESEMPIO - EXEMPLE

TR 2518 L3*

L=2540 P=430 H=1772 mm

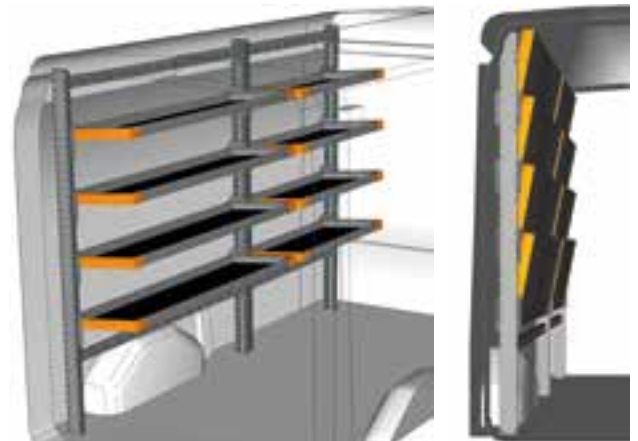
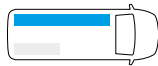

ESEMPIO - EXEMPLE

TR 2518 L4*

L=2540 P=430 H=1772 mm

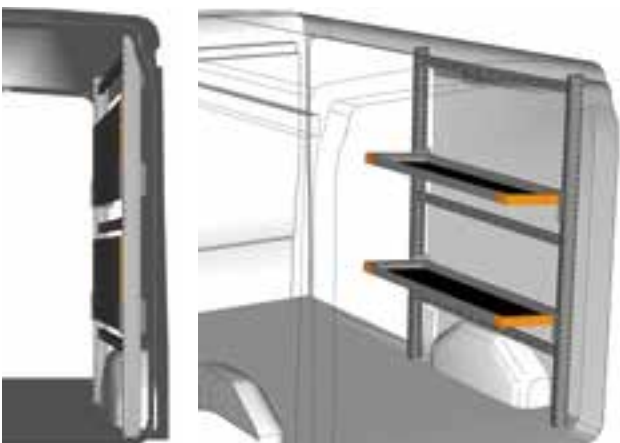

ESEMPIO - EXEMPLE

TR 1318 L1*

L=1310 P=430 H=1772 mm

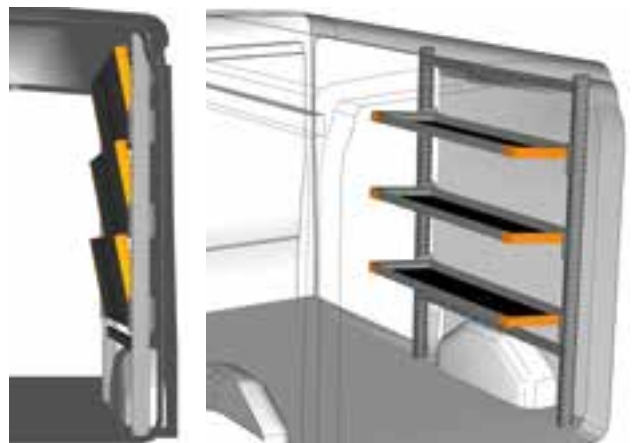
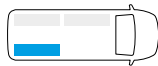

ESEMPIO - EXEMPLE

TR 1318 L2*

L=1310 P=430 H=1772 mm

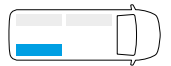

* Kit fissaggio incluso - Jeu de fixation inclus

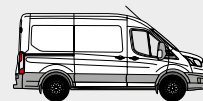

ESEMPI DI ALLESTIMENTO - EXEMPLES D'AMÉNAGEMENTS

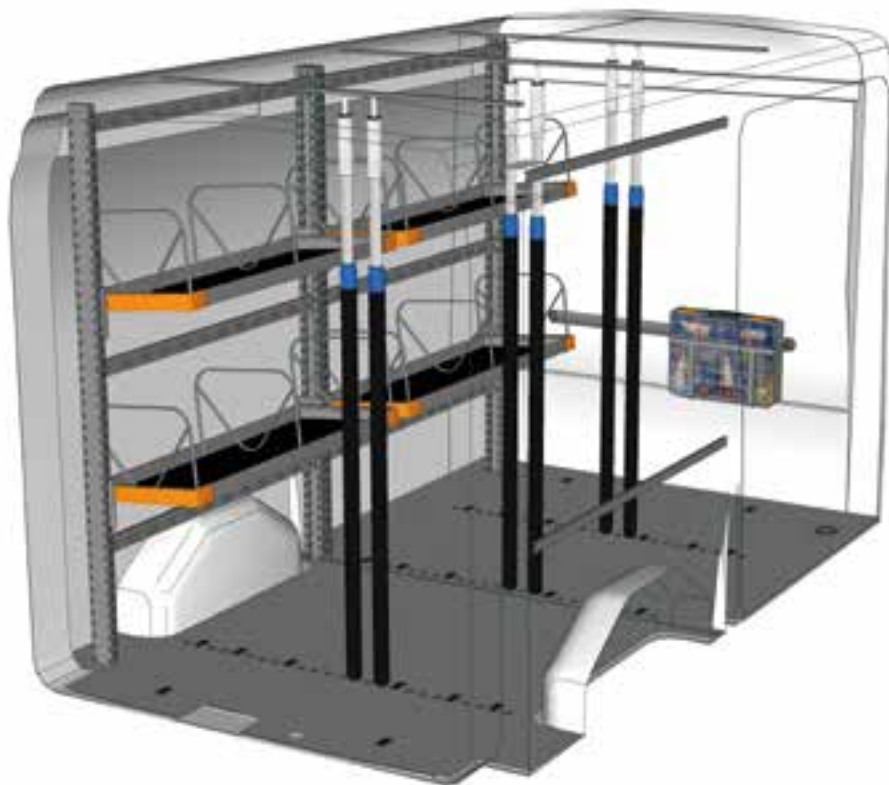

ESEMPIO - EXEMPLE

EXAMPLE TR L2H2 L1*



1 x TR 2518 L1	1 x BOX080
12 x 445D30	1 x CPV080
1 x TR 20G1 A0	2 x V22136
1 x V22585	2 x V22124
6 x V22017	2 x V22148
1 x V18029 10	1 x YELLOW
2 x V22106	4 x V225820
5 x V18025 15	

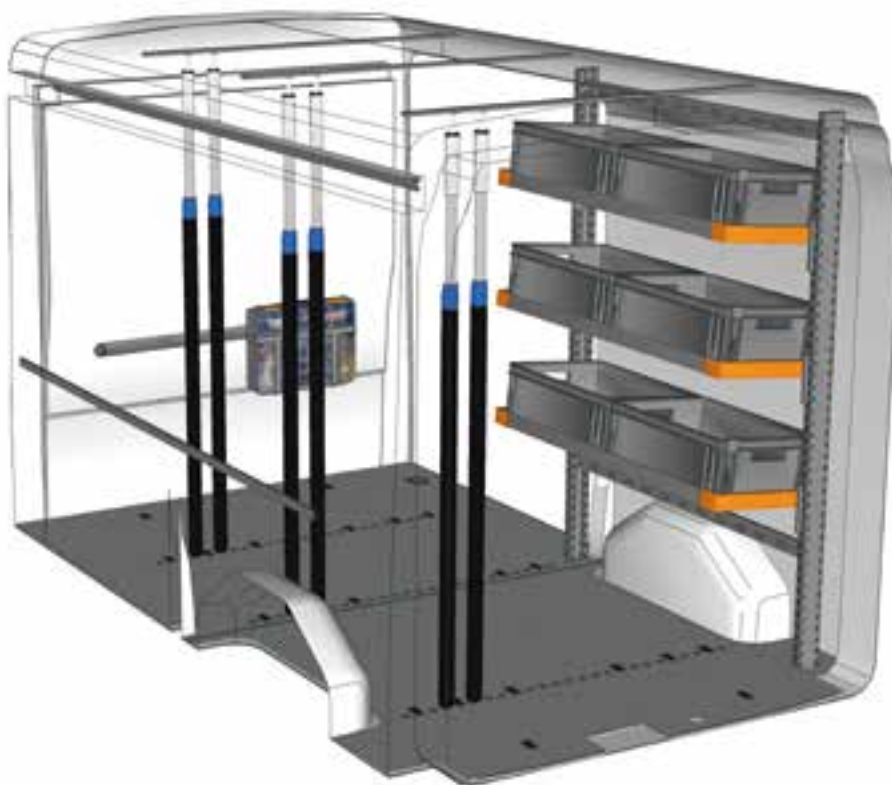

ESEMPIO - EXEMPLE

EXAMPLE TR L2H2 L2(*)(**)



1 x TR 1318 L2	1 x BOX080
1 x TR 20G1 A0	1 x CPV080
1 x V22585	2 x V22136
6 x V22017	2 x V22124
1 x V18029 10	2 x V22148
2 x V22106	1 x YELLOW
2 x V18025 25	4 x V225820
3 x V18025 15	



* Kit fissaggio incluso - Jeu de fixation inclus

** Contenitori esclusi - Bacs exclus

Non hai trovato il tuo allestimento?

Affidati ai nostri professionisti

Guarda il retro di questo catalogo e
contatta il punto Store Van piu vicino
oppure visita il nostro sito.

**Vous n'avez pas trouvé votre
équipement ? Confiez-vous
à nos professionnels**

Voir au dos de ce catalogue
et contactez le point StoreVan
le plus proche ou visitez notre site web.



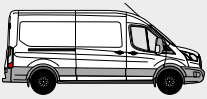

ESEMPI DI ALLESTIMENTO - EXEMPLES D'AMÉNAGEMENTS

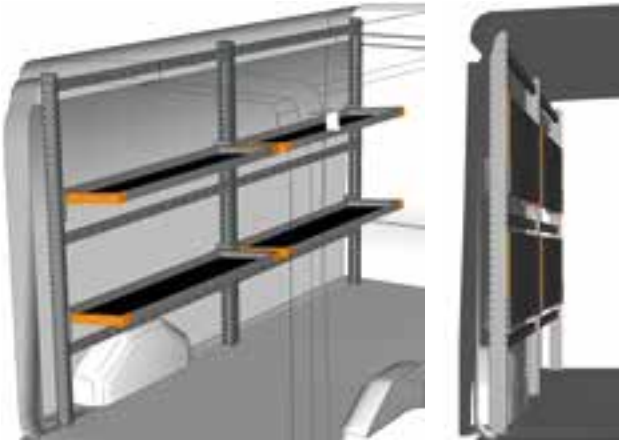

ESEMPIO - EXEMPLE

TR 3018 L1*

L=3048 P=430 H=1772 mm

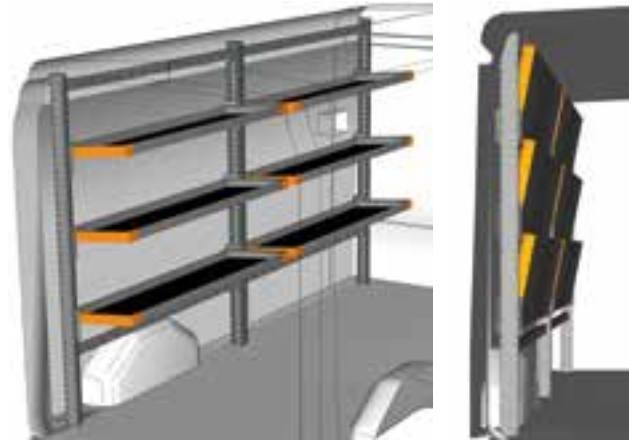
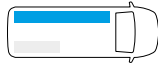

ESEMPIO - EXEMPLE

TR 3018 L2*

L=3048 P=430 H=1772 mm

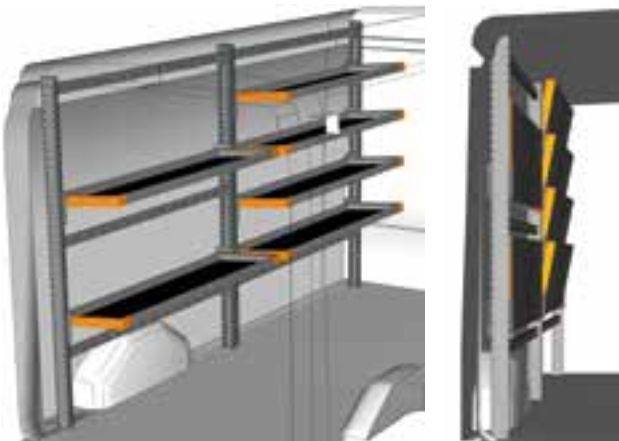

ESEMPIO - EXEMPLE

TR 3018 L3*

L=3048 P=430 H=1772 mm

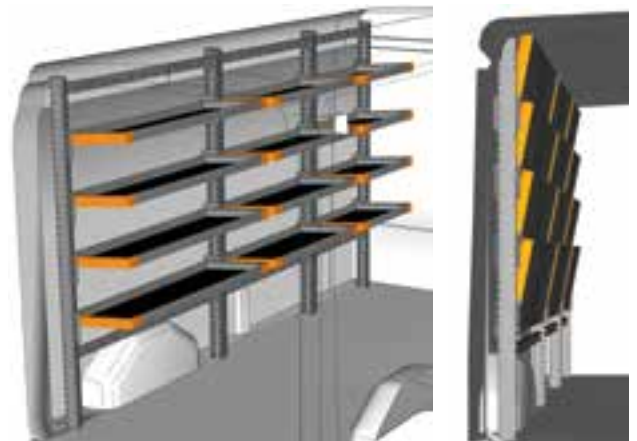
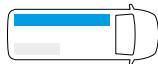

ESEMPIO - EXEMPLE

TR 3018 L4*

L=3043 P=430 H=1772 mm

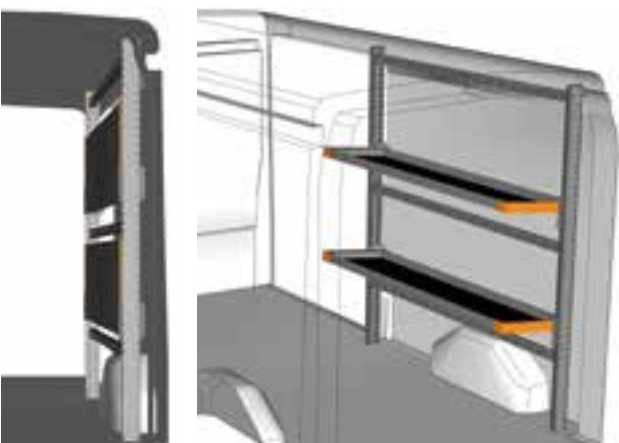

ESEMPIO - EXEMPLE

TR 1718 L1*

L=1733 P=430 H=1772 mm

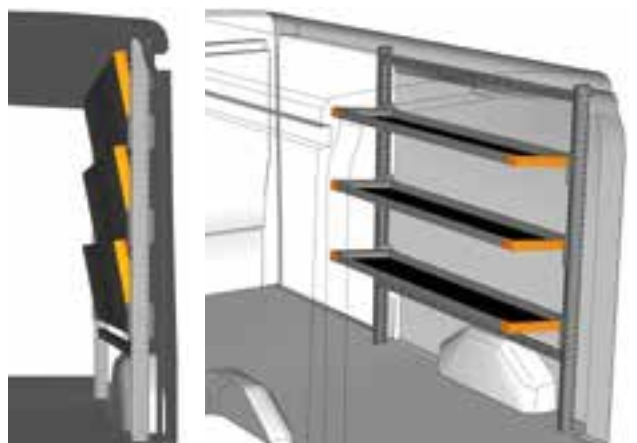
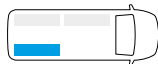

ESEMPIO - EXEMPLE

TR 1718 L2*

L=1733 P=430 H=1772 mm



* Kit fissaggio incluso - Jeu de fixation inclus



ESEMPI DI ALLESTIMENTO - EXEMPLES D'AMÉNAGEMENTS

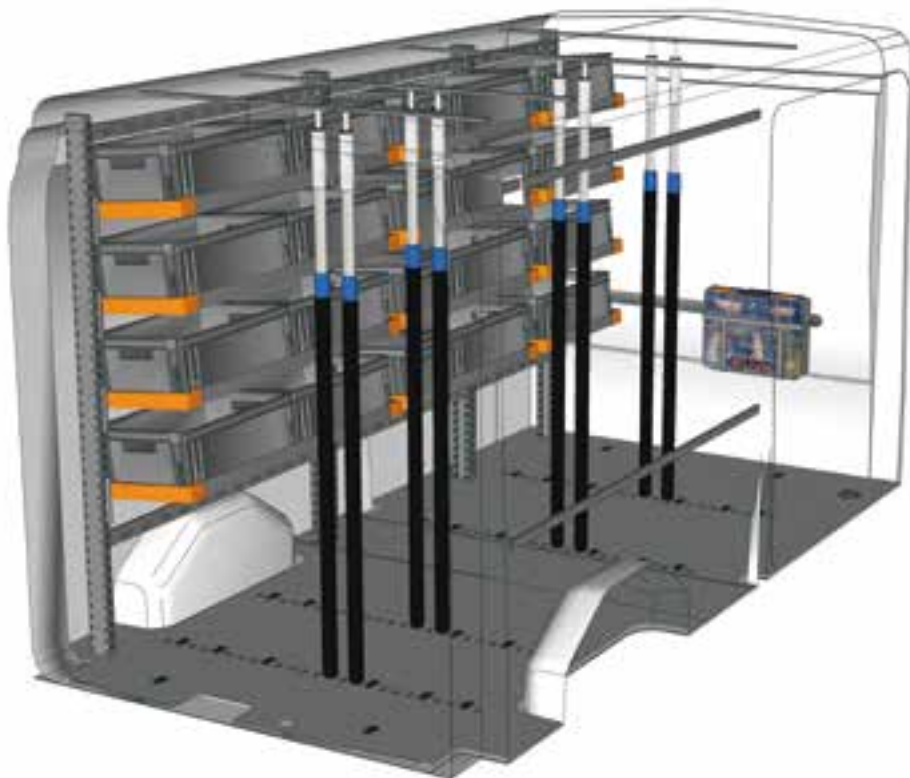

ESEMPIO - EXEMPLE

EXAMPLE TR L3H2 L1 (*)(**)



1 x TR 3018 L4	1 x BOX080
1 x TR 30G1 A0	1 x CPV080
1 x V22585	2 x V22136
8 x V22017	2 x V22124
1 x V18029 10	2 x V22148
2 x V22106	1 x YELLOW
4 x V18025 15	4 x V225820
2 x V18025 20	

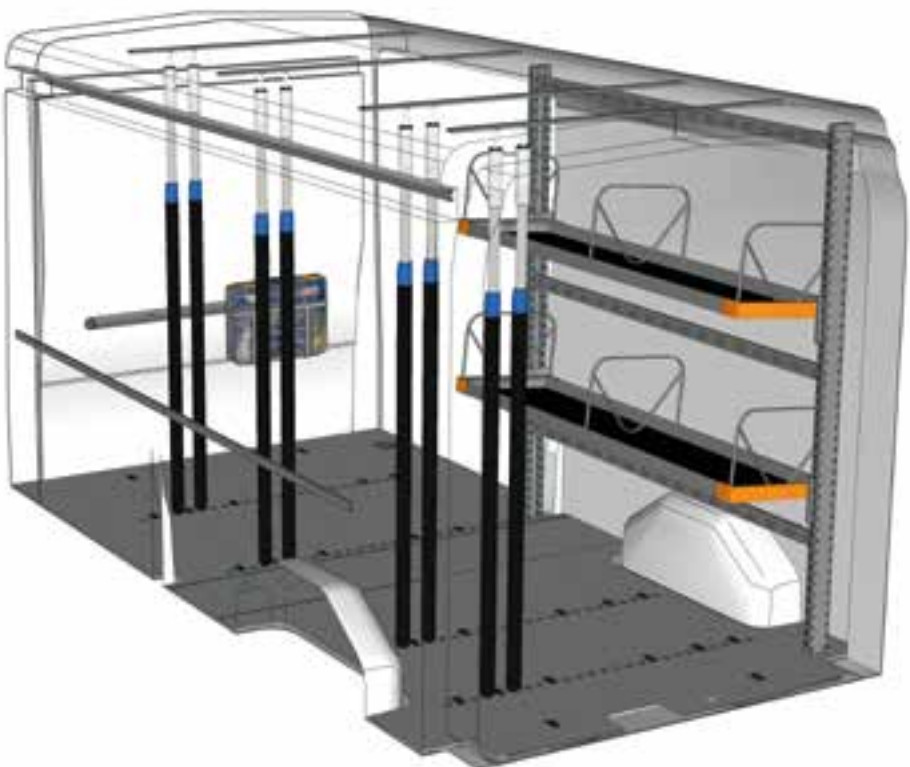

ESEMPIO - EXEMPLE

EXAMPLE TR L3H2 L2*



1 x TR 1718 L1	1 x V18025 20
6 x 445D30	1 x BOX080
1 x TR 30G1 A0	1 x CPV080
1 x V22585	2 x V22136
8 x V22017	2 x V22124
1 x V18029 10	2 x V22148
2 x V22106	1 x YELLOW
7 x V18025 15	4 x V225820



* Kit fissaggio incluso - Jeu de fixation inclus

** Contenitori esclusi - Bacs exclus

Non hai trovato il tuo allestimento?

Affidati ai nostri professionisti

Guarda il retro di questo catalogo e
contatta il punto Store Van più vicino
oppure visita il nostro sito.

**Vous n'avez pas trouvé votre
équipement ? Confiez-vous
à nos professionnels**

Voir au dos de ce catalogue
et contactez le point StoreVan
le plus proche ou visitez notre site web.



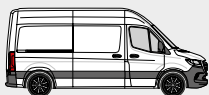

ESEMPI DI ALLESTIMENTO - EXEMPLES D'AMÉNAGEMENTS



ESEMPIO - EXEMPLE

SP 2818 L1*

L=2834 P=430 H=1772 mm

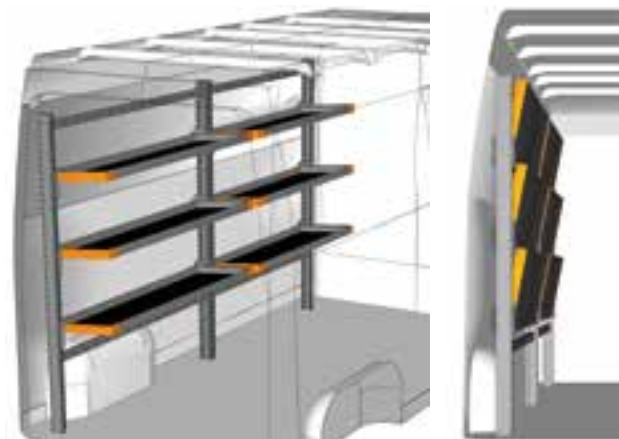
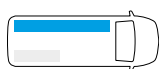

ESEMPIO - EXEMPLE

SP 2818 L2*

L=2834 P=430 H=1772 mm

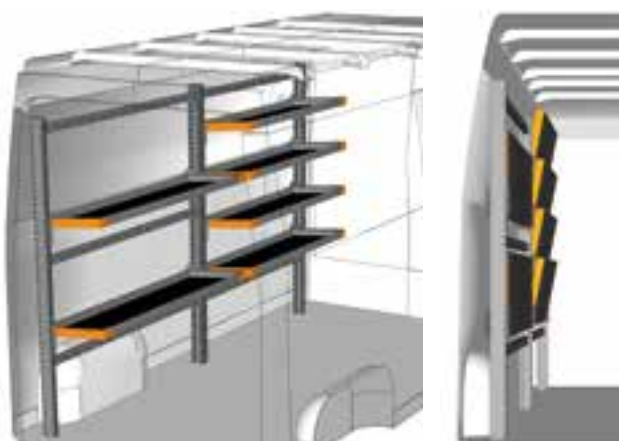
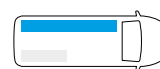

ESEMPIO - EXEMPLE

SP 2818 L3*

L=2834 P=430 H=1772 mm

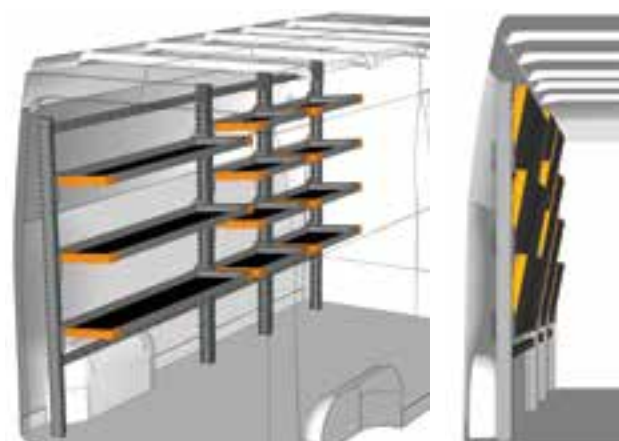
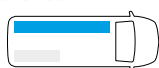

ESEMPIO - EXEMPLE

SP 2918 L1*

L=2958 P=430 H=1772 mm

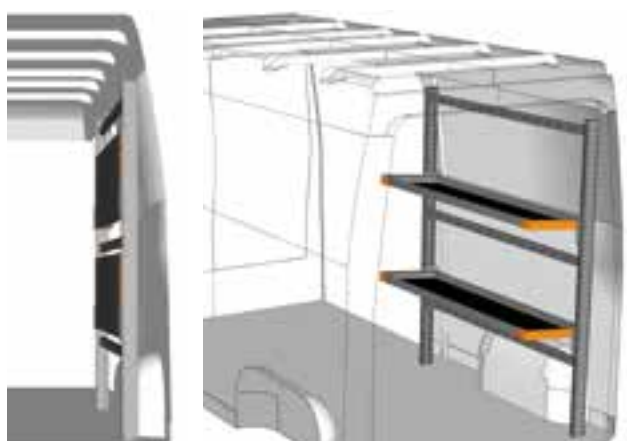
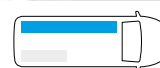

ESEMPIO - EXEMPLE

SP 1518 L1*

L=1524 P=430 H=1772 mm

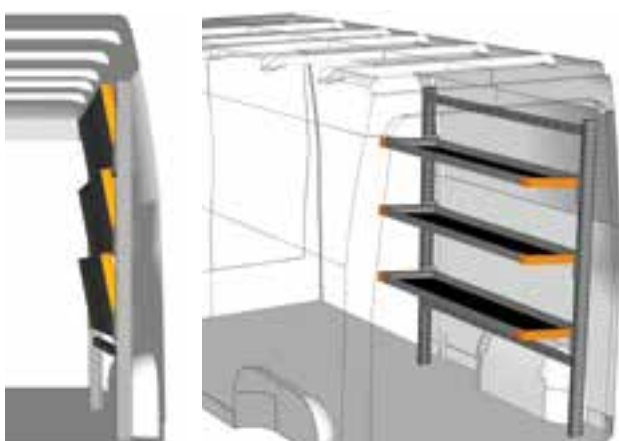
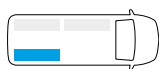

ESEMPIO - EXEMPLE

SP 1518 L2*

L=1524 P=430 H=1772 mm

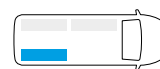

* Kit fissaggio incluso - Jeu de fixation inclus

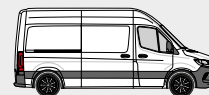

ESEMPI DI ALLESTIMENTO - EXEMPLES D'AMÉNAGEMENTS

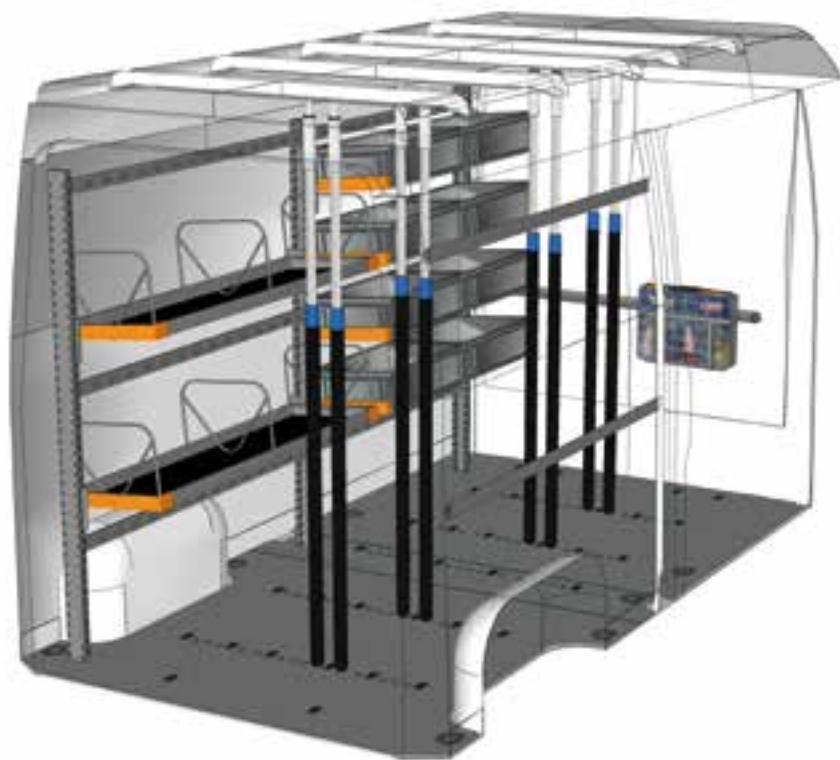

ESEMPIO - EXEMPLE

EXAMPLE SP L2H2 L1 FWD[*](**)



1 x SP 2818 L3	10 x V23389
6 x 445D30	1 x B0X080
1 x SP 20G1 A1	1 x CPV080
1 x V22585	2 x V22136
8 x V22017	2 x V22124
1 x V18029 15	2 x V22148
2 x V18029 20	1 x YELLOW
6 x V22106	4 x V22090
5 x V18025 15	

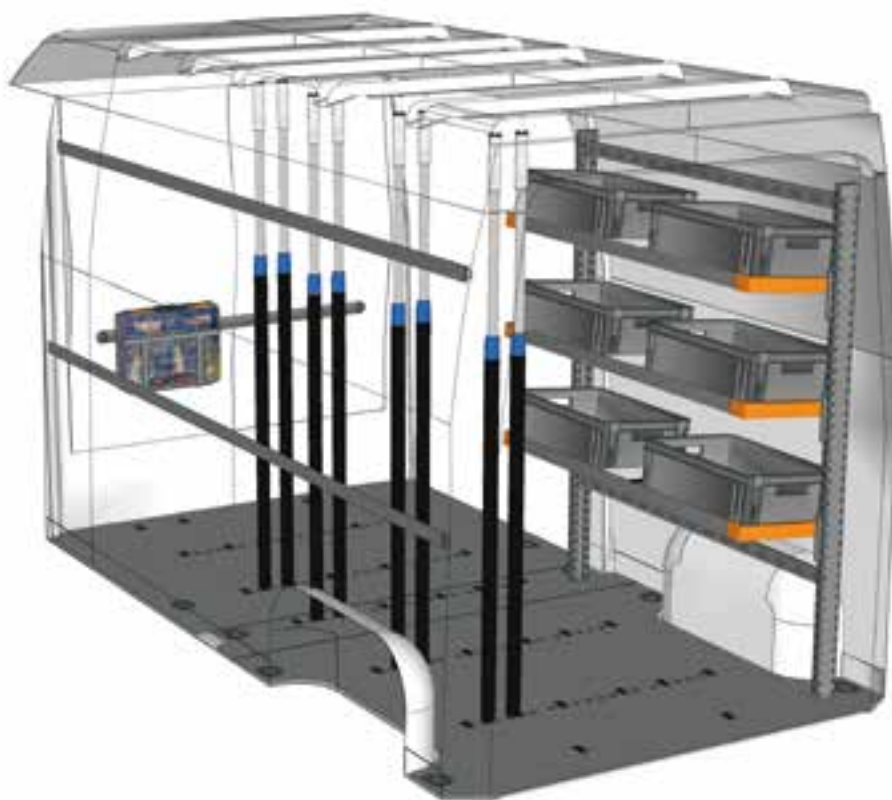

ESEMPIO - EXEMPLE

EXAMPLE SP L2H2 L2 FWD[*](**)



1 x SP 1518 L2	10 x V23389
6 x 445D05	1 x B0X080
1 x SP 20G1 A1	1 x CPV080
1 x V22585	2 x V22136
8 x V22017	2 x V22124
1 x V18029 15	2 x V22148
2 x V18029 35	1 x YELLOW
4 x V22106	4 x V22090
5 x V18025 15	



* Kit fissaggio incluso - Jeu de fixation inclus

** Contenitori esclusi - Bacs exclus

Non hai trovato il tuo allestimento?
Affidati ai nostri professionisti
Guarda il retro di questo catalogo e
contatta il punto Store Van piu vicino
oppure visita il nostro sito.

**Vous n'avez pas trouvé votre
équipement ? Confiez-vous
à nos professionnels**
Voir au dos de ce catalogue
et contactez le point StoreVan
le plus proche ou visitez notre site web.



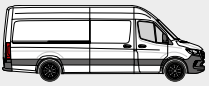

ESEMPI DI ALLESTIMENTO - EXEMPLES D'AMÉNAGEMENTS

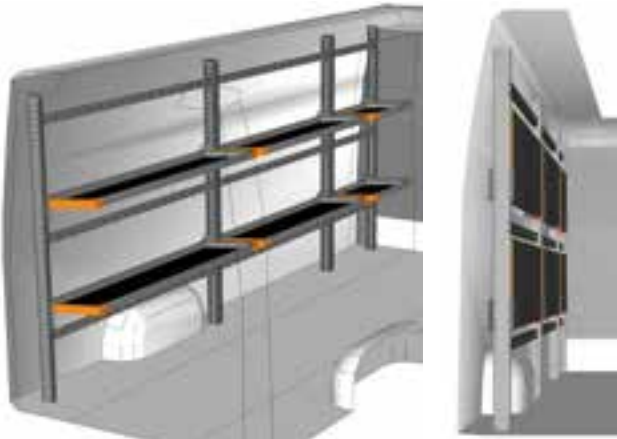

ESEMPIO - EXEMPLE

SP 3918 L1*

L=3974 P=430 H=1772 mm

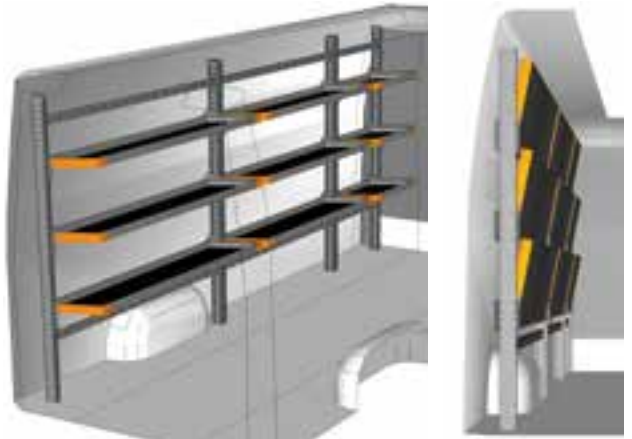
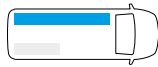

ESEMPIO - EXEMPLE

SP 3918 L2*

L=3974 P=430 H=1772 mm

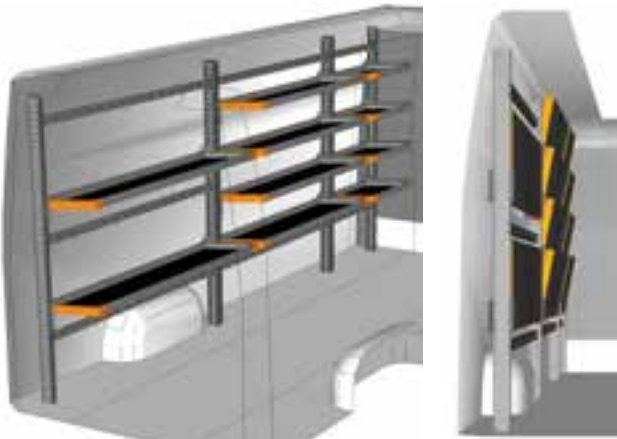

ESEMPIO - EXEMPLE

SP 3918 L3*

L=3974 P=430 H=1772 mm

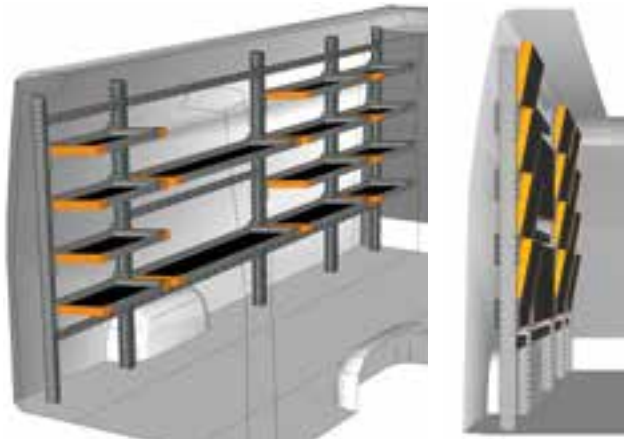
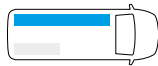

ESEMPIO - EXEMPLE

SP 3918 L4*

L=3974 P=430 H=1772 mm

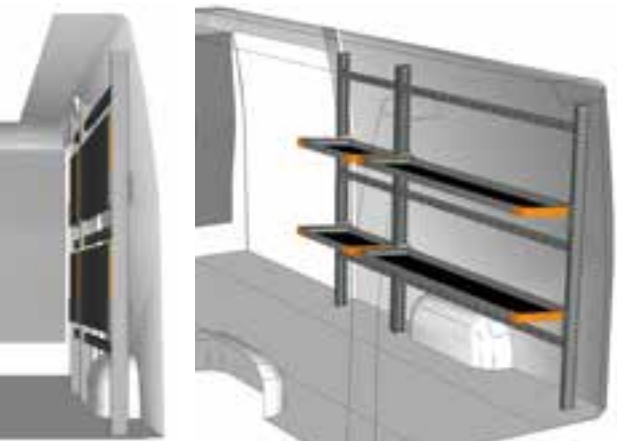

ESEMPIO - EXEMPLE

SP 2418 L1*

L=2450 P=430 H=1772 mm

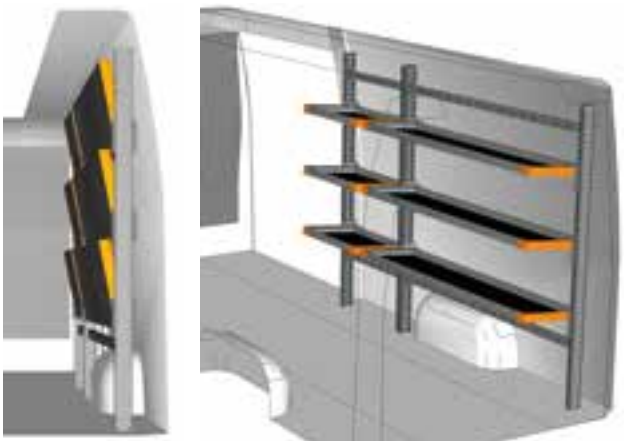
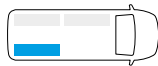

ESEMPIO - EXEMPLE

SP 2418 L2*

L=2450 P=430 H=1772 mm

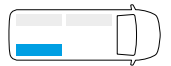

* Kit fissaggio incluso - Jeu de fixation inclus

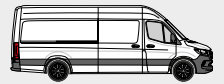

ESEMPI DI ALLESTIMENTO - EXEMPLES D'AMÉNAGEMENTS

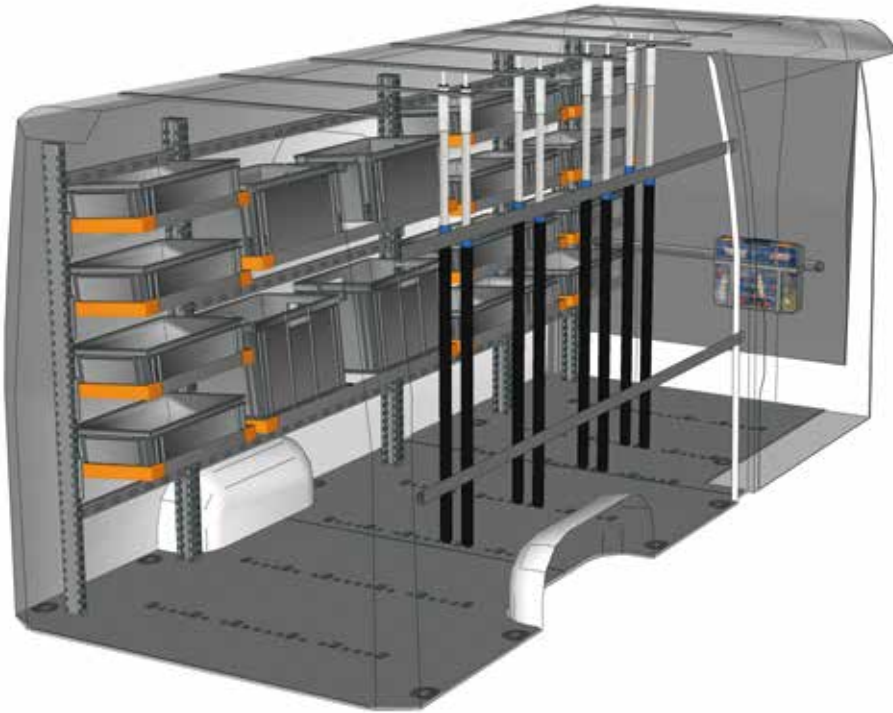

ESEMPIO - EXEMPLE

EXAMPLE SP L3H2 L1 RWD(*)(**)



1 x SP 3918 L4	14 x V23389
4 x 445D05	1 x B0X080
1 x SP 30G1 J1	1 x CPV080
1 x V22585	2 x V22136
8 x V22017	2 x V22124
1 x V18029 15	2 x V22148
2 x V18029 30	1 x YELLOW
6 x V22106	4 x V22090
7 x V18025 15	

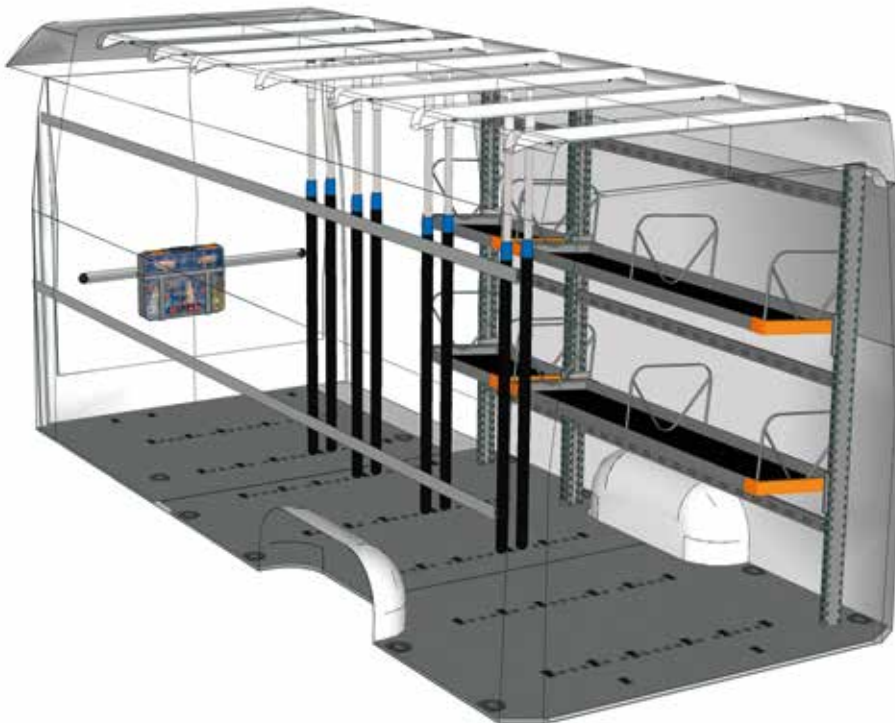

ESEMPIO - EXEMPLE

EXAMPLE SP L3H2 L2 RWD*



1 x SP 2418 L1	14 x V23389
10 x 445D30	1 x B0X080
1 x SP 30G1 J1	1 x CPV080
1 x V22585	2 x V22136
8 x V22017	2 x V22124
1 x V18029 15	2 x V 22148
2 x V18029 45	1 x YELLOW
4 x V22106	4 x V22090
7 x V18025 15	

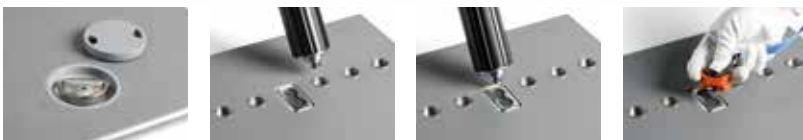

* Kit fissaggio incluso - Jeu de fixation inclus

** Contenitori esclusi - Bacs exclus

Non hai trovato il tuo allestimento?

Affidati ai nostri professionisti

Guarda il retro di questo catalogo e
contatta il punto Store Van più vicino
oppure visita il nostro sito.

**Vous n'avez pas trouvé votre
équipement ? Confiez-vous
à nos professionnels**

Voir au dos de ce catalogue
et contactez le point StoreVan
le plus proche ou visitez notre site web.



LIGHT SHELF

RIPIANI RIBALTABILI PER FURGONI
ÉTAGÈRES RABATTABLES POUR FOURGONS



FAMI S.R.L.

VIA STAZIONE ROSSANO, 13 – 36027 ROSÀ (VI) ITALY
TEL +39 0424 585455 R.A. – FAX +39 0424 585482
INFO@FAMISPA.COM – WWW.FAMISPA.COM

INFO@STOREVAN.COM – WWW.STOREVAN.COM

